

furniture123

USER MANUAL

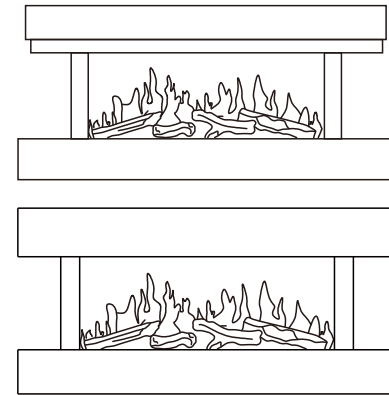

AmberGlo Electric Fire with LED Effect Lights

AGL037 / AGL053 / AGL054 / AGL055

Thank you for choosing this AmberGlo electric flame effect heater.
Please read this guide aims to improve your understanding and appreciation of
your new heater, and please retain it for future reference.

CONTENTS

SAFETY	3
PARTS SUPPLIED	6
PRODUCT DIAGRAM	7
INSTALLATION	8
OPERATION	10
APP CONNECTION	12
CARE AND MAINTENANCE	19
BATTERY INFORMATION	19
TECHNICAL SPECIFICATION	19
TROUBLESHOOTING	20
SUPPORT	21
PRODUCT FICHE	22

Model Identifier: AGL037 / AGL053 / AGL054 / AGL055					
Item	Symbol	Value	Unit	Item	Unit
Heat Output				Type of heat input, for electric storage local space heaters only (select one)	
Nominal heat output	P _{nom}	2.0	kW	manual heat charge control, with integrated thermostat	No
Minimal heat output	P _{min}	1.0	kW	manual heat charge control with room and/or outdoor temperature feedback	No
Maximum continuous heat output	P _{max}	2.0	kW	electronic heat charge control with room and/or outdoor temperature feedback	No
Auxiliary electricity consumption				fan assisted heat output	No
At nominal heat output	e _{lmax}	1.988	kW	Type of heat output/room temperature control (select one)	
At minimum heat output	e _{lmin}	0.990	kW	single stage heat output and no room temperature control	No
In standby mode	e _{lsb}	0.002	kW	two or more manual stages, no room temperature control	No
				with mechanical thermostat room temperature control	No
				with electronic room temperature control	No
				with electronic room temperature control plus day timer	No
				with electronic room temperature control plus week timer	Yes
				Other control options (multiple selections possible)	
				room temperature control with presence detection	No
				room temperature control, with open window detection	Yes
				with distance control option	Yes
				with adaptive start control	No
				with working time limitation	No
				with black bulb sensor	Yes
Contact Details	BuyItDirect, Unit J6, Lowfields Business Park, Lowfields Way, Elland, West Yorkshire, HX5 9DA				

SAFETY INFORMATION

When using electrical appliances, basic safety precautions should always be followed, including the following:

- **IMPORTANT:** Read all instructions and warnings carefully before starting installation. Failure to follow these instructions may result in a possible electric shock or fire hazard and will void the warranty.
- Before connecting the appliance, be sure that the mains voltage available matches that specified on the rating plate, and that the outlet is suitably grounded.
- This appliance can be used by children aged from 8 years and above and persons with reduced physical, sensory or mental capabilities or lack of experience and knowledge if they have been given supervision or instruction concerning use of the appliance in a safe way and understand the hazards involved.
- Children aged from 3 years and less than 8 years shall only switch on/off the appliance provided that it has been placed or installed in its intended normal operating position and they have been given supervision or instruction concerning use of the appliance in a safe way and understand the hazards involved. Children aged from 3 years and less than 8 years shall not plug in, regulate, or clean the appliance or perform user maintenance.
- Children under 3 years should be kept away unless continuously supervised.
- Some parts of this product can become very hot and cause burns. Particular attention has to be given where children and vulnerable people are present.
- If the supply cord is damaged, it must be replaced by the manufacturer, its service agent or a similarly qualified person in order to avoid a hazard.
- **WARNING:** In order to avoid overheating, do not cover the heater.
- **CAUTION:** In order to avoid a hazard due to the inadvertent resetting of the thermal cut-out, this appliance must not be supplied through an external switching device, such as a timer, or connected to a circuit that is regularly switched on and off by the utility.
- Do not attempt to repair, disassemble or modify the appliance. This unit contains no user-serviceable parts.
- Always unplug or disconnect the appliance from the mains power supply when not in use, or when moving or cleaning it. Do not pull the cord to unplug the heater.
- Keep the heater clean. Do not allow any object to enter the ventilation or exhaust opening as this may cause electric shock, fire, or damage to the heater.
- Do not use the appliance for other than its intended use. It is designed for domestic indoor use only.
- There may be a trace of odour during the first few minutes of initial use, or after a period of storage. This is normal and will quickly disappear.
 - ▪ If the glass is damaged, do not use the heater in order to avoid a hazard.
 - ▪ Avoid the use of an extension cord, as the cord may overheat and cause a risk of fire.
 - ▪ This fireplace is hot when in use. To avoid burns, do not let bare skin touch any hot

surfaces.

- Keep combustible materials, such as furniture, pillows, bedding, papers, clothes and curtains at least 1 metre from the front and sides of this appliance.
- This appliance is designed for indoor use only and is not intended for use in bathrooms, laundry areas and similar indoor locations. Never locate this appliance where it may become exposed to water.
- Do not place this fire directly onto a carpeted surface to avoid discolouration due to the heat.
- Do not run the cord under carpeting. Do not cover the cord with throw rugs, runners or the like. Ensure the cord is kept away from traffic areas, and kept in a position which would not present a trip hazard.
- To disconnect this appliance, Press the On/Off button to turn off, then remove the plug from the outlet.
- This appliance has hot and arching or sparking parts inside. Do not use it in areas where gasoline, paint, or any flammable liquids are used or stored.
- This appliance should not be used as a drying rack for clothing, nor should Christmas stockings or decorations be hung on or near it.
- This electric fire is an instant heat source to warm up a room and is great for visual room ambiance it doesn't necessarily need to be used as a constant or permanent source of heating for the home.
- Clean the fire regularly to prevent the build-up of hairs, dust or lint around the fire, as this may cause the outlet to become blocked.
- Do not use aerosols or steam cleaners on or around the fire.

Manual Handling

- The heater must not be moved while in use. Please allow a suitable amount of time for the unit to cool before attempting to move it.
- One person should be sufficient to lift the heater. If for any reason it is considered too heavy then obtain assistance.
- When lifting always keep your back straight. Bend your legs and not your back.
- Avoid twisting at the waist. It is better to reposition your feet.
- Avoid upper body / top heavy bending. Always bend from the knees rather than the waist. Do not lean forward or side ways whilst handling the heater.
- Always grip with the palm of the hand. Do not use the tips of fingers for support.
- Always keep the heater as close to the body as possible. This will minimize the cantilever action.
- If required, use gloves to provide additional grip.
- Always use assistance if required.

SUPPORT

Please, for your own convenience, make these simple checks before calling the service line.

If the unit still fails to operate call: 0330 390 3062 or complete the online form

1. Is the unit plugged into the mains?
2. Is the fuse OK?
3. Switch the unit off and wait ten minutes to see if the issue is resolved. Restart the unit.

Office hours: 9AM - 5PM Monday to Friday

BuyItDirect
Unit J6, Lowfields Business Park,
Lowfields Way, Elland,
West Yorkshire, HX5 9DA



TROUBLESHOOTING

Most problems are simple to resolve—please refer to the following table before calling a service engineer:

Problem	Possible Cause	Check
Fire has stopped working	The fire has overheated and the thermal safety device has activated or a circuit breaker has tripped.	Check there is power to the socket where the fire is connected, check the fuse in the plug, check the main power switch on the unit is turned on and leave for 10 minutes in case of thermal cut-out.
Flame is not moving	Flame motor defective	Contact the retailer or manufacturer.

SERVICING

It is hazardous for anyone, other than a qualified service technician, to carry out any service or repair operation, which involves removal of any components. The lighting for the flame effect is by LED bulbs which are designed to last for the life of the product and are not user replaceable.

WASTE ELECTRICAL RECYCLING

Disposal: Do not dispose this product as unsorted municipal waste. Collection of such waste must be handled separately as special treatment is necessary.



Recycling facilities are now available for all customers at which you can deposit your old electrical products. Customers will be able to take any old electrical equipment to participating civic amenity sites run by their local councils. Please remember that this equipment will be further handled during the recycling process, so please be considerate when depositing your equipment. Please contact the local council for details of your local household waste recycling centres.

ELECTRICAL SAFETY

The heater must not be located under an electrical socket; the socket must always be accessible in order to disconnect the heater from the electrical supply for maintenance and cleaning.

Important! This heater must be earthed. The mains supply must be safely routed from the heater to an electrical socket.

If the supply cord is damaged, it must be replaced by the manufacturer, service agent or a similarly qualified person in order to avoid a hazard.

This appliance is supplied with a BS1363 3 pin plug fitted with a 13 Amp fuse. Should the fuse require replacement, it must be replaced with a fuse rated at 13 Amp and approved to BS1362.

In the event the mains plug has to be removed or replaced for any reason, please note:

The wires in the mains lead on this appliance are coloured in accordance with the following code:

Green and Yellow - Earth
Blue - Neutral
Brown - Live

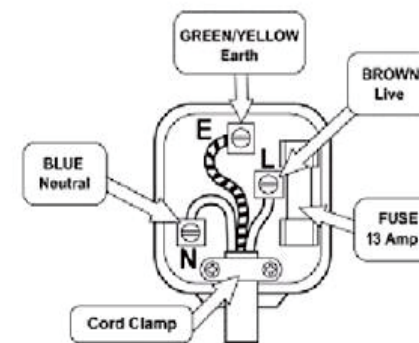

As the colours may not correspond with the markings identifying the terminals in your plug, please proceed as follows.

- The green and yellow wire must be connected to the terminal in the plug which is marked with the letter E or with the earth symbol \perp or coloured green and yellow.
- The blue wire must be connected to the terminal marked N or coloured black.
- The brown wire must be connected to the terminal marked L or coloured red.

Important - any cut off plug should be disposed of safely to prevent a hazard. There is a danger of electric shock if a cut off plug is inserted into a socket outlet.

PARTS SUPPLIED

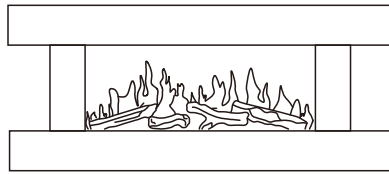

Fireplace



Remote



Screw x 6



Wall Plug x 6



Washer x 6



Pebbles 0.9Kg

Crystals 0.5Kg

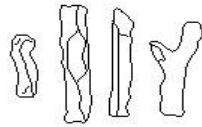

Logs x 4

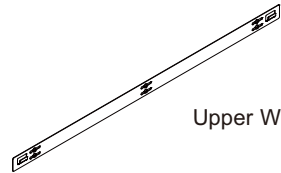

Upper Wall Bracket

Please Note: Some parts are packaged within the cavity of the surround on the rear of the fire.

BEFORE USE!

Before using the appliance for the first time, ensure that it has been fully unpacked, and that all packaging has been disposed of properly to ensure it does not present a risk to children or animals.

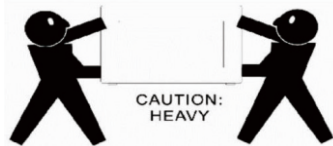

Due to the size and weight of the fire, we would advise on 2 people carrying out installation to prevent injury or damage.

CARE AND MAINTENANCE

Before cleaning the appliance, the power supply should be disconnected and the unit should be allowed to cool.

Dust can be removed by lightly wiping the glass surface with clean, lint free cloth or paper towel. To remove finger prints or other marks, use a damp cloth with a good quality household glass cleaner. The front glass panel should be completely dried before reusing the heater.

⚠ CAUTION:

- Do not use abrasive cleaner on glass panel.
- Do not spray liquids directly onto any surface of the unit.
- Do not clean the glass on the inside of the unit as this may cause damage to the surface

REPLACING THE BATTERIES

The remote control takes a CR2025 battery. If the remote becomes unresponsive, please change the battery with a new battery, as shown in the image.

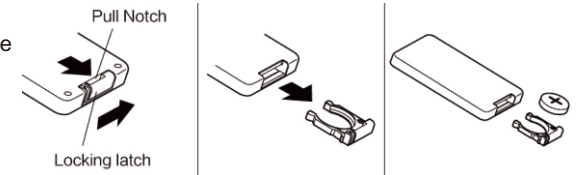

TECHNICAL SPECIFICATION

Description of Product	Electric Wall Hanging Fire			
Rated Voltage	220-240V ~			
Rated Frequency	50/60 Hz			
Rated Power	Max 2000W			
Model	AGL037	AGL053	AGL054	AGL055
Dimensions (mm)	1300 (W)	1205 (W)	1205(W)	1205 (W)
	595 (H)	589 (H)	589 (H)	589 (H)
	230 (D)	250 (D)	250 (D)	250 (D)
Net Weight	30.5Kg	25.5Kg	25.5Kg	24.7Kg

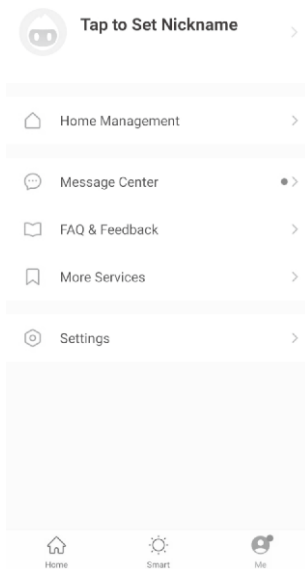

PROFILE TAB

The profile tab gives you the option to edit both your detail, and use the added features of the unit.

HOME MANAGEMENT

Home Management proves options for managing your TUYA account, giving options such as adding a home, adding and removing rooms, and sharing devices with family.

MESSAGE CENTRE

View notifications from devices, if alarms are set up (dependent on device)

HELP CENTRE

Provides assistance using the features provided within the app

MORE SERVICES

This allows the unit to be integrated with your favorite home automation hardware such as Google Home and the Amazon Echo.

FAQ AND FEEDBACK

Access frequently asked questions and troubleshoot issues.

CONNECTION TROUBLESHOOTING

1. Check whether the device is powered on and is in the correct WiFi connection mode, if not please refer to the CHANGING BETWEEN CONNECTION MODES section.
2. Ensure the WiFi password has been entered into the app correctly (Case sensitive)
3. Check that the phone is connected to the WiFi you are connecting the device to.
4. Ensure the network you are connecting it to is 2.4G hz (5Ghz WiFi networks are not supported),and that there is a strong WiFi signal to the item.
5. If your router is dual band, ensure that the 2.4ghz network has a different network name (SSID). Further advice on changing router settings will be available from your Internet service provider/Router manufacturer.
6. Check the settings on the router.Encryption should be WPA2 -PSK and authorisation type should be set to AES.
7. Try using the alternative connection method. If connection is failing when attempting to connect through CF mode, try AP mode.

PRODUCT DIAGRAM

AGL037 (This model is both for free standing & wall mounting.)

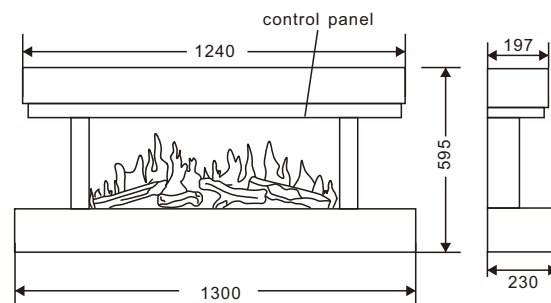

AGL053/AGL054 (This model is both for free standing & wall mounting.)

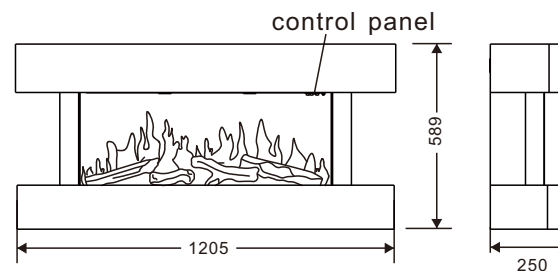

AGL055 (This model is both for free standing & wall mounting.)

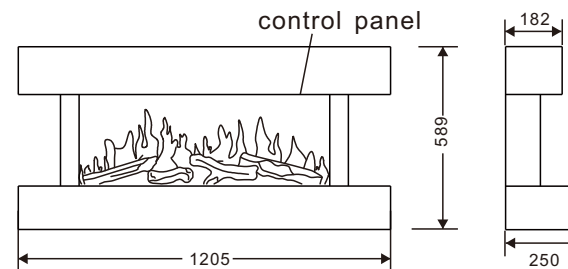

INSTALLATION INSTRUCTIONS

This product is designed to be mounted flat to the wall. Before installation please ensure that the floor and wall are flat, and there is nothing that would prevent the fire fitting flush.

1. The fire is designed to be permanently fixed to a wall with a minimum distance of 300mm between the base of the fire and the floor. A distance of 600mm is recommended for the optimum height on the wall.
2. The upper bracket should be placed against the wall 490mm above the planned position of the base of the fire.
3. While ensuring that the bracket is level (using a spirit level) mark the position of the six screw holes in the wall.
4. Put the bracket to one side, drill the holes marked in step 3 with an 8mm drill bit to a depth of around 35mm.
5. Clean any dust and debris from drilling, and insert a wall plug into each hole, ensuring they are flush with the surface of the wall.
6. Hold the bracket in position and attach to the wall using 6 screws.
7. Two people should carefully lift the fire into position, ensuring the top edge of the fire engages with the bracket.
8. Spread the supplied pebbles / branches (model dependant) in position on the light at the front of the unit.

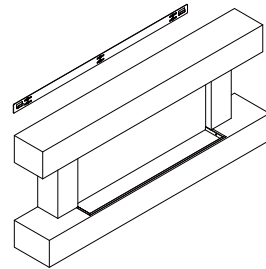
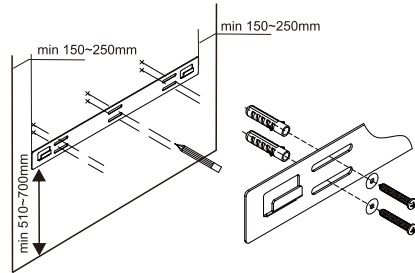

NOTES:

The wall plugs supplied are designed for solid walls, and so depending on the type of wall, a different type of plug may be required. Before drilling into the wall, you must ensure that there is no pipework or wiring behind the wall which may be damaged during installation. The fire must be installed by a competent person, if in any doubt about installation, the suitability of the wall, or wall plugs supplied, professional advice should be sought.

DEVICE SCREEN

The device screen is the main control screen for the heater, providing access to the controls to amend the functions and settings.

Back: Returns to the Home Screen

Device Name

Edit Name: Use to change the name of the heater. Device information and third part control can also be assessed from this menu.

Desired Temperature: Displays what has been set as the target room temperature.

Current Temperature: Displays what the current temperature is.

Decrease Desired Temperature
Temperature range 18-35°C

Increase Desired Temperature
Temperature range 18-35°C

Power: Use to turn the unit on or off.

Flame colour: Use to change the flame colour between C1 and C7.

Heating: Use to turn the heating OFF/ON/LOW/HIGH.

Countdown Timer: Use to set the countdown timer between 1 and 9 hours.

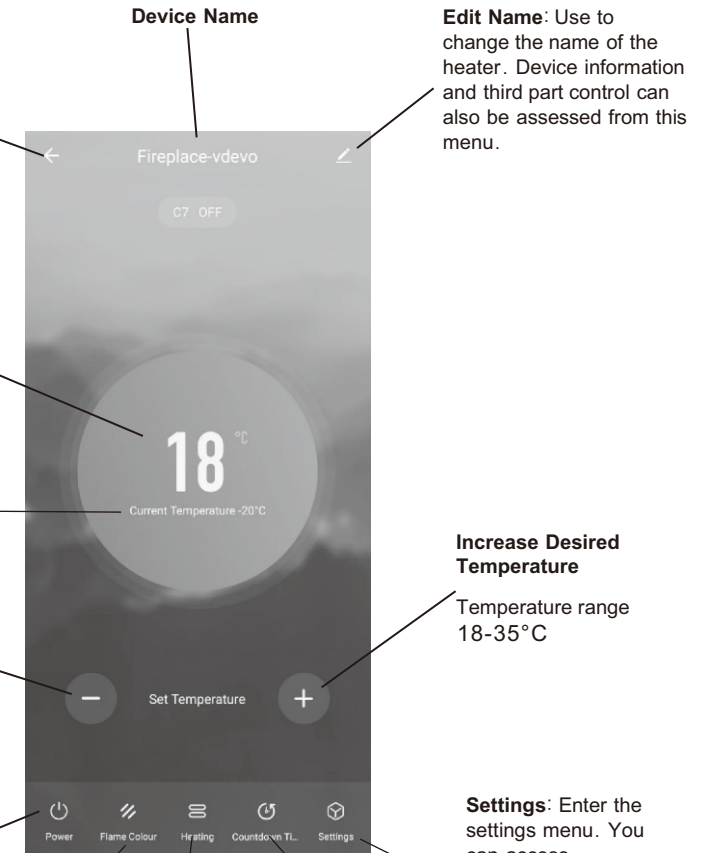

CONTROLLING YOUR APPLIANCE THROUGH THE APP THE HOME SCREEN

NOTE: Due to continuous development of the app, the layout and available features may be subject to change.

Each device has its own entry on the home screen to allow the user to either quickly turn the unit on or off, or to enter the device screen to make other changes.

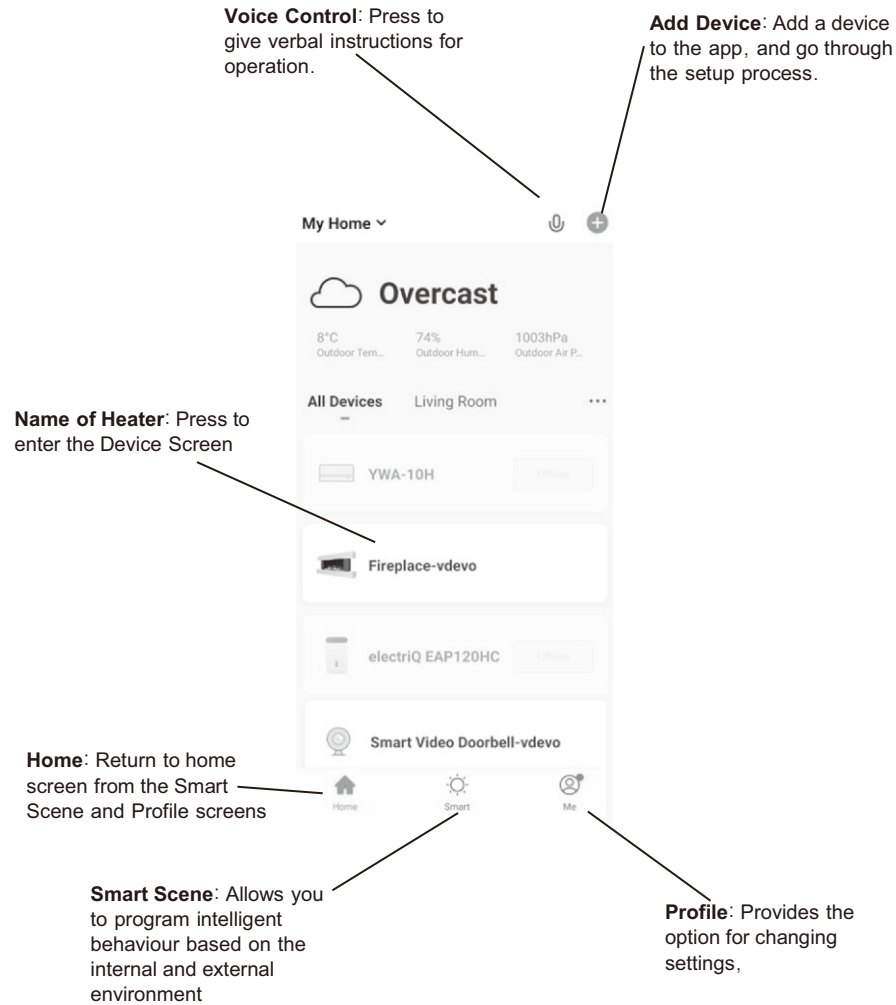

STEPS TO REPLACE DECORATION (FOR AGL037);

1. Remove the two screws with a phillips screwdriver
2. Take off the glass, the put decoration well (small pebble/crystal/log set supplied)
3. Install the glass carefully.

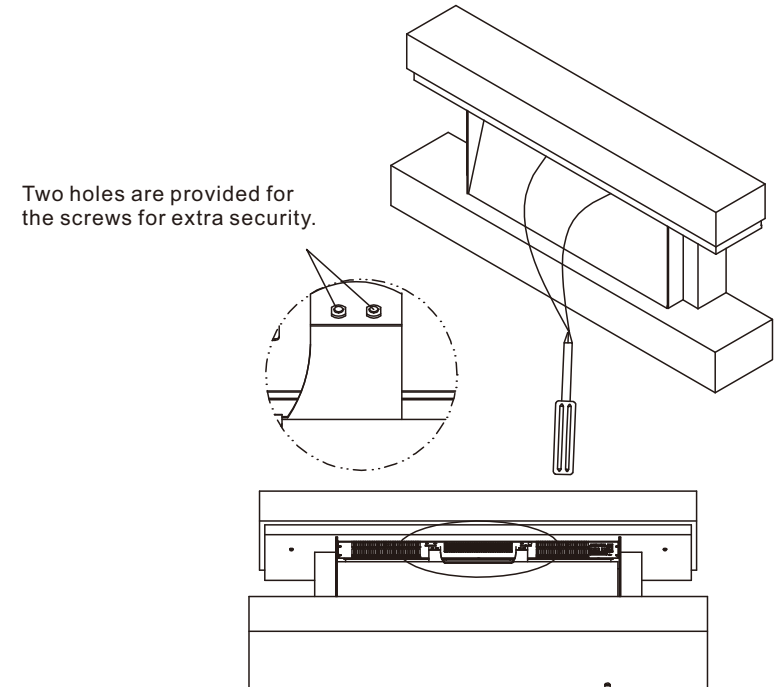

OPERATION

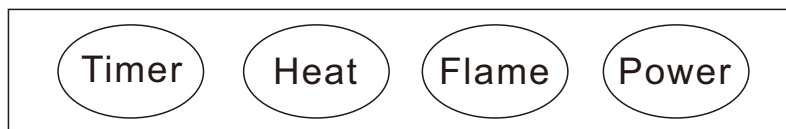

ON/OFF	<p>Press the power button to turn the unit On or Off. In standby mode, press and hold the power button for 3 seconds to set the wireless network (see Wi-Fi connection).</p> <p>Press and hold the power button for 5 seconds in standby mode to toggle between Celsius and Fahrenheit.</p>
FLAME CONTROL	<p>Press the flame button rapidly to adjust the flame brightness. There are 5 levels with 5 being the brightest and one the dimmest.</p> <p>Press and hold the flame button for 5 seconds to enter the flame colour settings. You can choose between the colours</p> <p>C1 Warm white + Red + Blue. C2 Warm white + Red C3 Red + Blue C4 Warm white + Blue C5 Blue C6 Red C7 Warm white</p>
HEAT CONTROLLER	<p>Press the heat button repeatedly to change the heat level. The heat level is indicated on the display by a bar. A small bar means the heat is LOW a large bar means the heat is HIGH. Press and hold the heat button to set the temperature between 18 and 35°C.</p>
TIMER	<p>You can set 0-9 hours in 1-hour increments. As soon as the time you set has elapsed, the fire will automatically go out. To adjust the you hear a beep and "F1" is displayed on the screen. The press the timer button repeatedly to select one of the colours. Once you reach "F9", the setting mode is exited and the colour selection start again.</p>

CONNECTING USING AP MODE (ALTERNATIVE METHOD)

Before initiating the connection, make sure the unit is in standby mode, with the WiFi Indicator flashing once per second. If not follow the instructions for changing the WiFi connection mode. Also ensure your phone is connected to the WiFi network. (We advise turning mobile data off during setup)

- Open app and press "+" to add device, or use the add device button

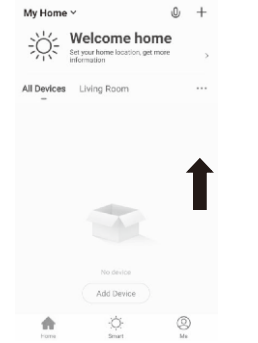
- Select the type of device as "Heater" within the Home Appliance tab.

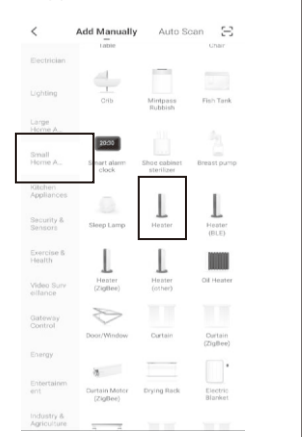

- Press on the AP mode button in the top right of the screen.



Power on the device and confirm that indicator light rapidly blinks

How to make indicator rapidly blink

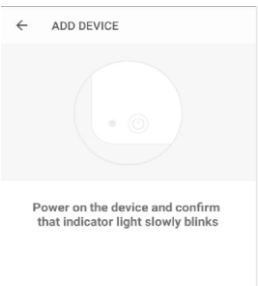
Confirm indicator rapidly blink
- Ensure the WiFi indicator on the heater is slowly flashing (once per second), then press on the orange button at the bottom of the screen to confirm

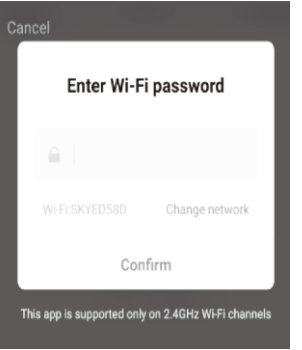

Power on the device and confirm that indicator light slowly blinks
- Enter your WiFi password and press confirm.

- Go to network settings in your phone and connect to the "SmartLife xxx" connection. There is no password to enter. Then return back to the app to complete setup.



This will then transfer the settings to the heater.





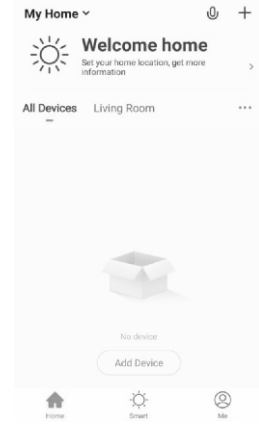
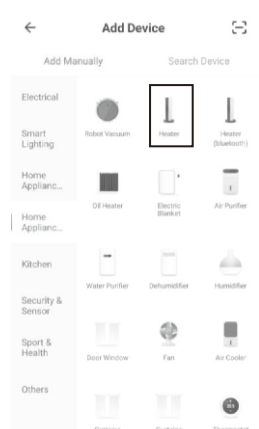
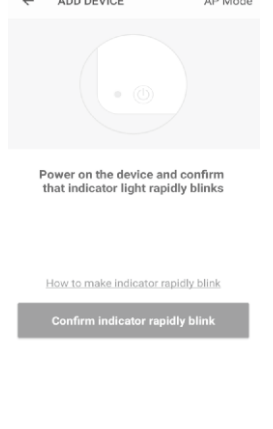
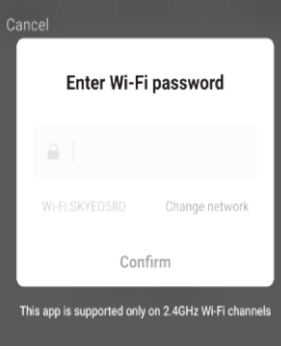
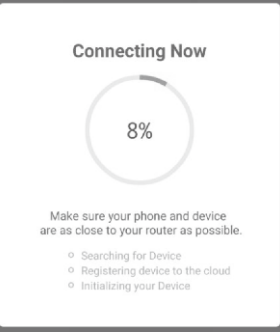

Once the connection process has completed, go back to the network settings on your phone to ensure your phone has reconnected to your WiFi router.

CONNECTING USING THE QUICK CONNECTION METHOD

Before initiating the connection, make sure the WiFi indicator is flashing twice per second. If not follow the instructions for changing the connection mode. Also ensure your phone is connected to the WiFi network. (We advise turning mobile data off during setup)

<p>1. Open app and press "+" to add device, or use the add device button</p> 	<p>2. Select the type of device as "Heater" within the Home Appliance tab.</p> 	<p>3. Press on the orange button at the bottom of the screen.</p> 
<p>4. Enter your WiFi password and press confirm.</p> 	<p>5. This will then transfer the settings to the heater. Wait for this to complete. If this fails, retry.</p> 	

REMOTE CONTROL

<p>Power Button </p>	<p>Press to turn the appliance On and Off.</p>
<p>Flame Button </p>	<p>To adjust the flame brightness: Press this button once and then adjust the flame brightness using the arrow buttons. To adjust the flame colour, press the flame button twice, then use the Arrow buttons to switch between flame colours (C1 -C7).</p>
<p>Arrow Buttons  </p>	<p>Press these buttons to select between the different heating levels. The level you select is shown on the heat indicator. When the small bar lights up, a low heating level is set. When both bars are lit, a high heating level is set.</p>
<p>Temperature Button </p>	<p>Press this button once and use the arrow buttons to select the desired temperature (18-35°C)</p>
<p>Timer On / Off </p>	<p>While the unit is on, press this button to set the time until it switches off automatically. You can set 0-9 hours in 1-hour increments. As soon as the time you set has elapsed, the fire will automatically go out. To adjust the you hear a beep and "F1" is displayed on the screen. Then press the timer button repeatedly to select one of the colours. Once you reach "F9", the setting mode is exited and the colour selection start again.</p>



DISPLAY

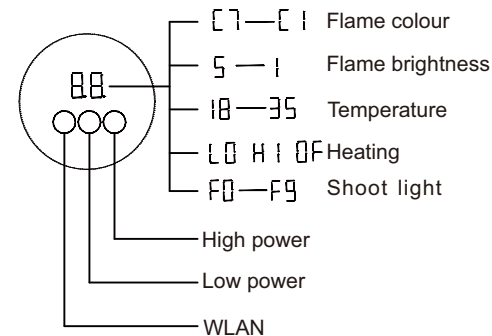

APP CONNECTION

NOTE: Some images may differ from the current app due to continuous product improvement.

1. Press on the register button at the bottom of the screen.

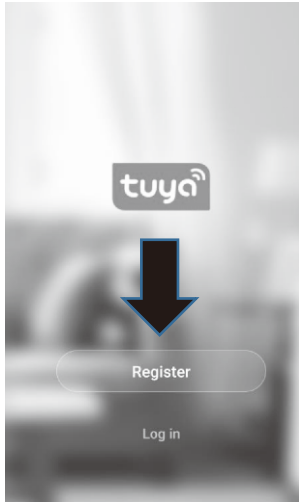

2. Read the Privacy policy and press the Agree Button.

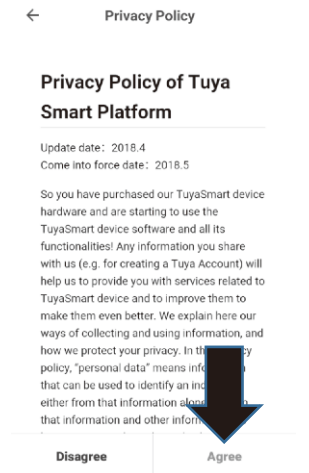

3. Enter your email address or phone number and press continue to register.

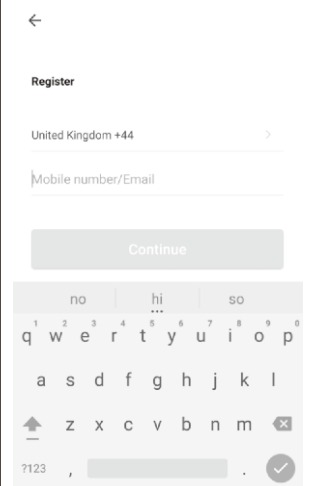

4. A verification code will be sent by the method selected in step 3. Enter the code into the app.

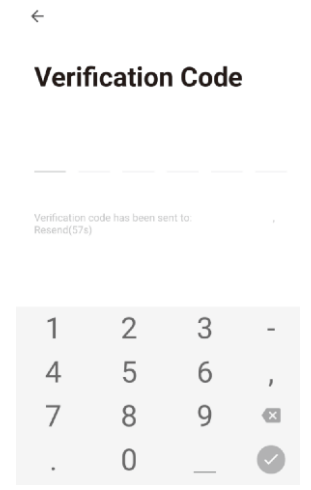

5. Type in the password you would like to create. This needs to be 6-20 characters, with letters and numbers.

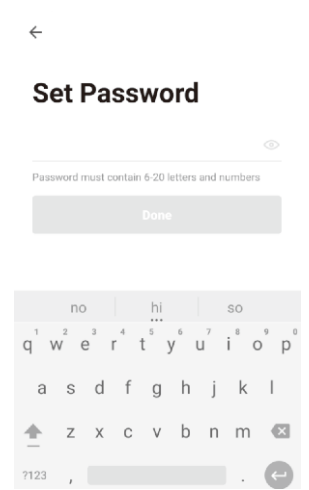

2. The app is now registered. It will automatically log you in following registration.

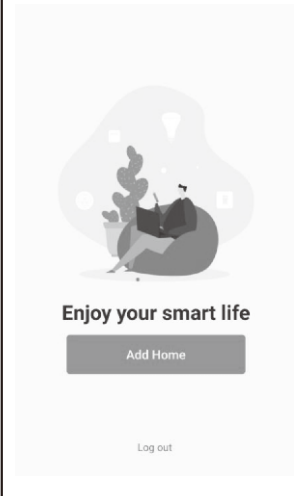

SETTING UP YOUR HOME WITHIN THE APP

TUYA is designed so it can work with a large number of compatible smart devices within your home. It can also be set up to work with multiple devices within different houses as such during the setup process, the app requires that different areas are created and named to allow easy management of all your devices. When new devices are added, they are assigned to one of the rooms you have created.

CREATING ROOMS

1. Press on the ADD HOME button.

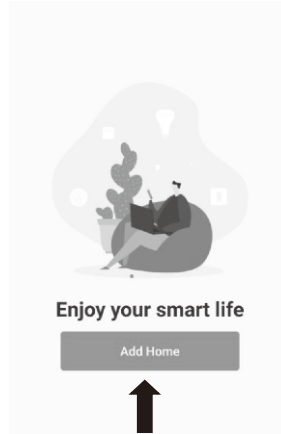

3. Type in a name for your home,
4. Press on the location button to select the location of your home. (See SETTING YOUR LOCATION below)
5. New rooms can be added by pressing the ADD ANOTHER ROOM option at the bottom. (See ADD ANOTHER ROOM below)
6. Untick any rooms that are not required on the app.
7. Press DONE in the top right corner.

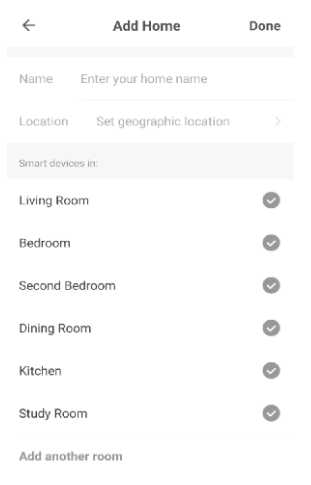

SETTING YOUR LOCATION

Use your finger to move the orange HOME symbol.

When the symbol is in the approximate location of your home, press the confirm button in the top right corner.

Location details allows the app to be set up later to respond to weather conditions in your area.

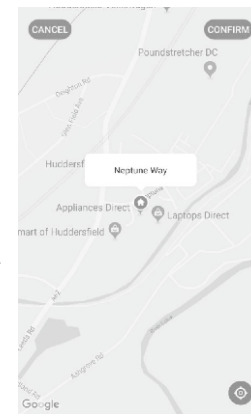

ADD ANOTHER ROOM

Type in the name of the room, and press Done in the top right corner

