

Orla & Isaac cot

Assembly instructions

Product Size 1244 x 670 x 860 mm

Version reference 001

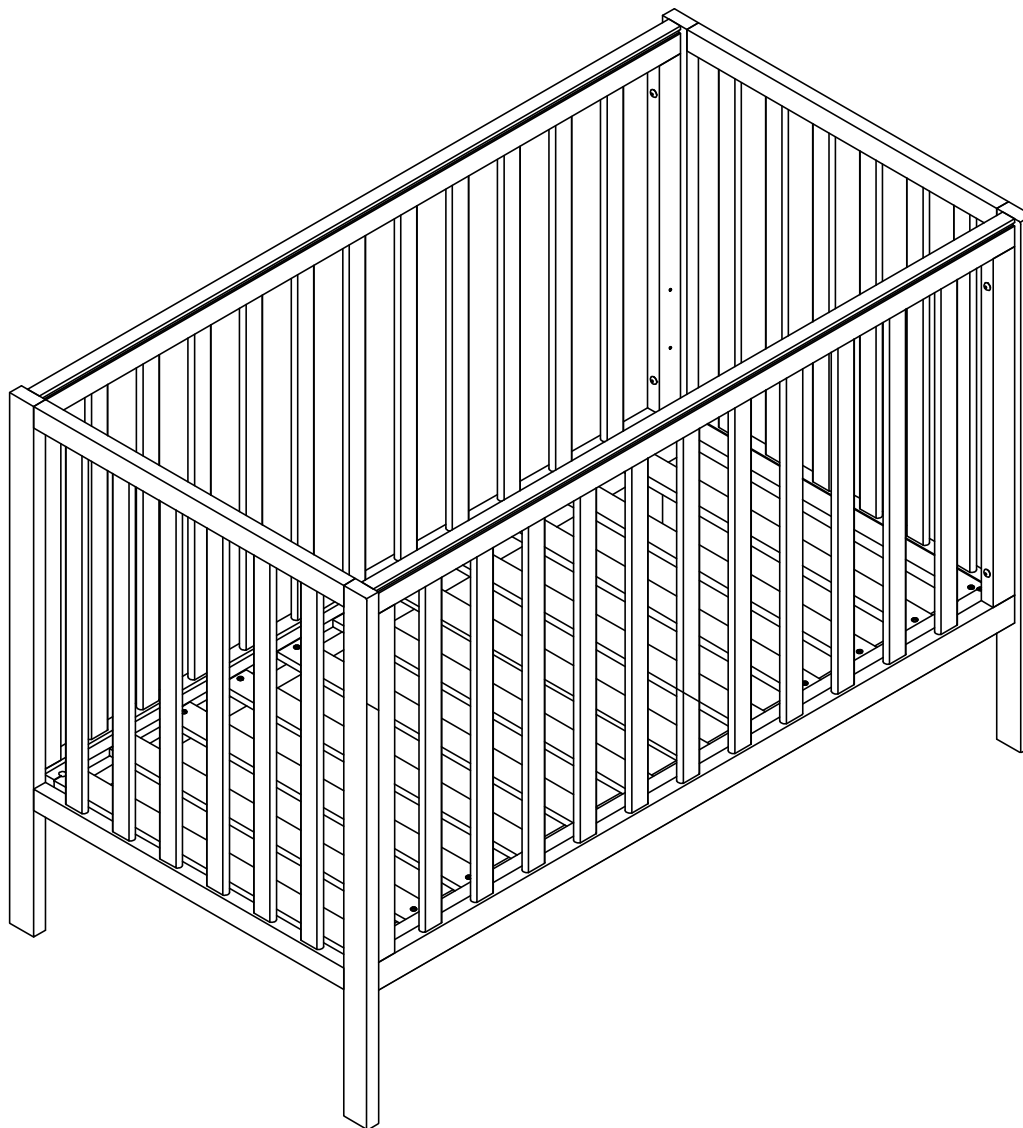

IMPORTANT : Before you start please read the instructions in full and keep for future reference.



When you are ready to start, make sure that you have plenty of space and a clean, dry area for assembly.

Due to the size of this product we recommend that it is assembled in the room intended for use.

Unwrap all packaging materials and place the components on top of the carton box or on a clean floor to prevent it from scratching.

Check the pack and make sure you have all the parts listed.

Do not use power tools to construct this product.

Do not over tighten screws or bolts.

Do not use scourers, abrasives (including washing powders), bleach or solvent based cleaners as they can bleach or damage the product

Should your product be faulty or have missing parts then please contact our customer services department who will be happy to assist you, please have your order number or batch code or date stamp ready.

Customer services 0871 984 1924





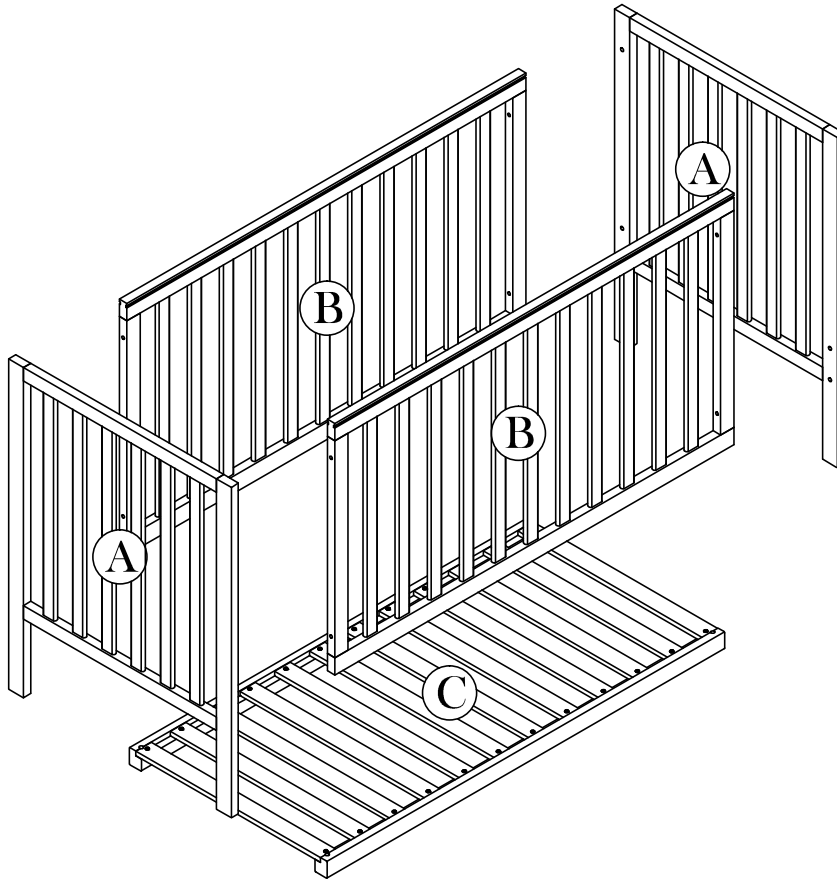

PARTS LIST



HARDWARE LIST

Hardware Pack

Code	Description	Dimension	Q'ty
1		1/4" * 51(Ø15)	8 pcs
2			4 pcs
3		1/4" * 15 mm	4 pcs
4		1/4" * 110 mm	1 pc
5		Ø10 * 35 mm	4 pcs

Step 1

①  8 pcs

⑤  4 pcs

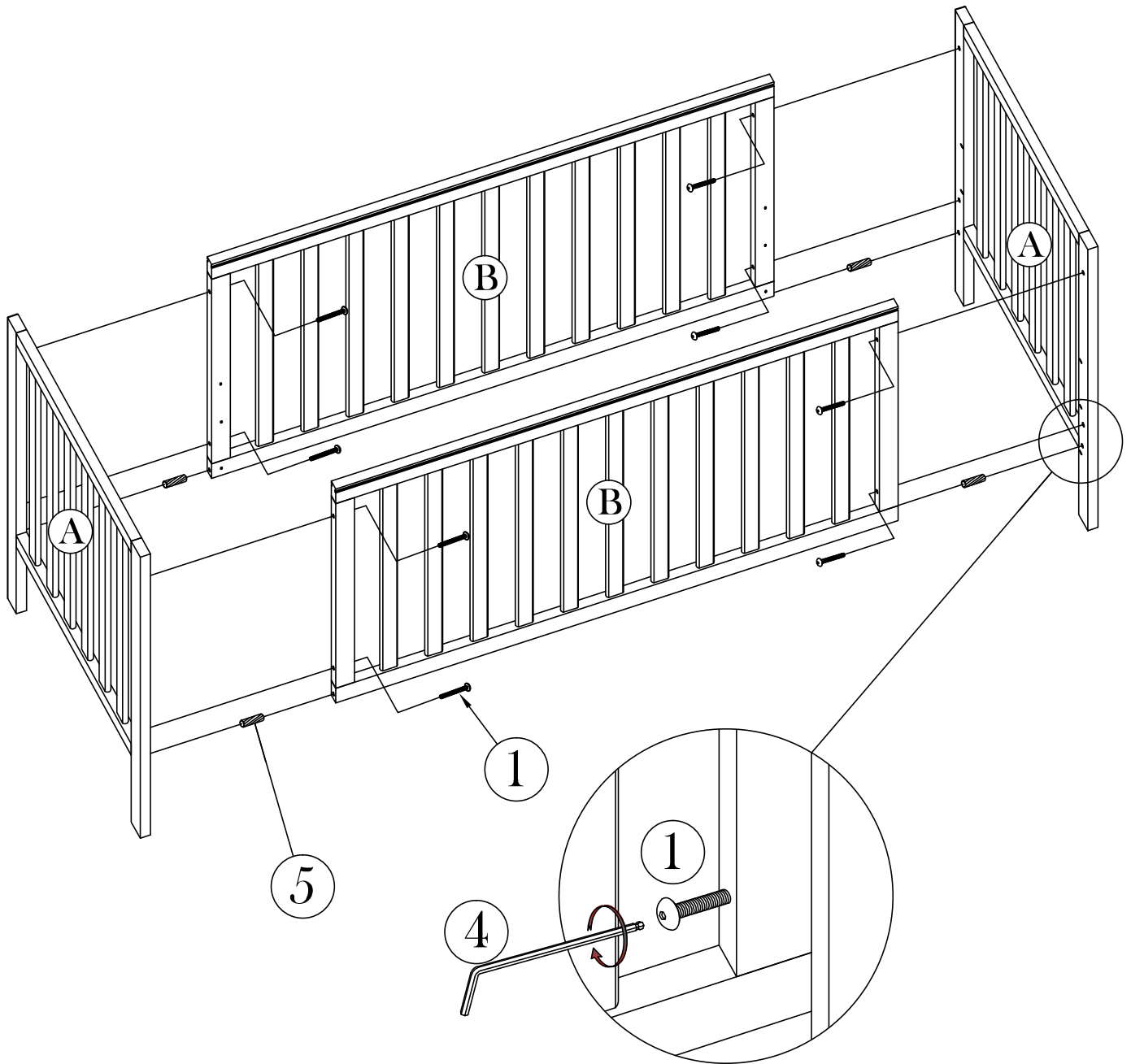

Step 2

②  4 pcs

③  4 pcs

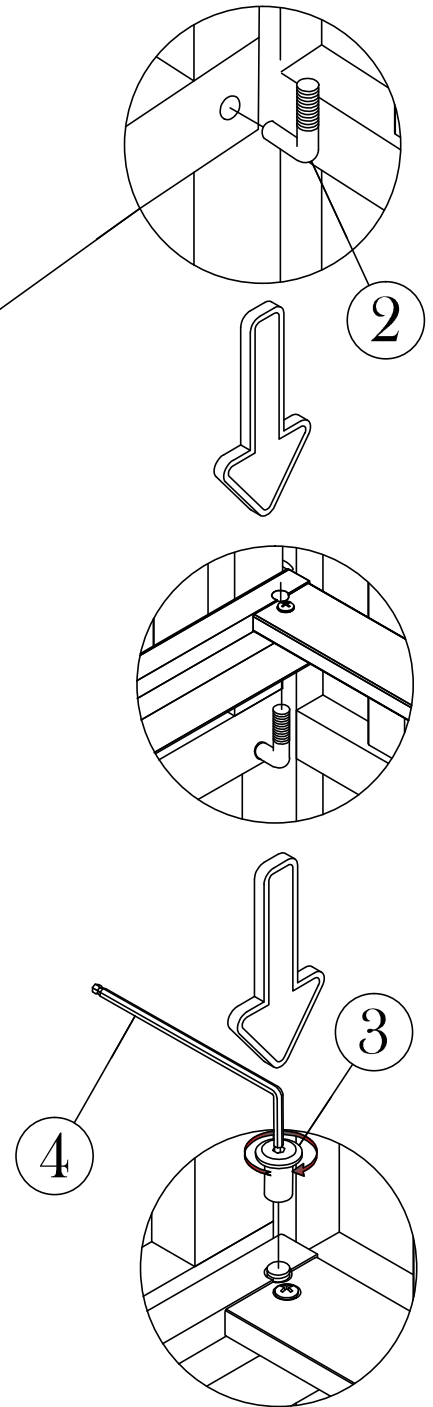
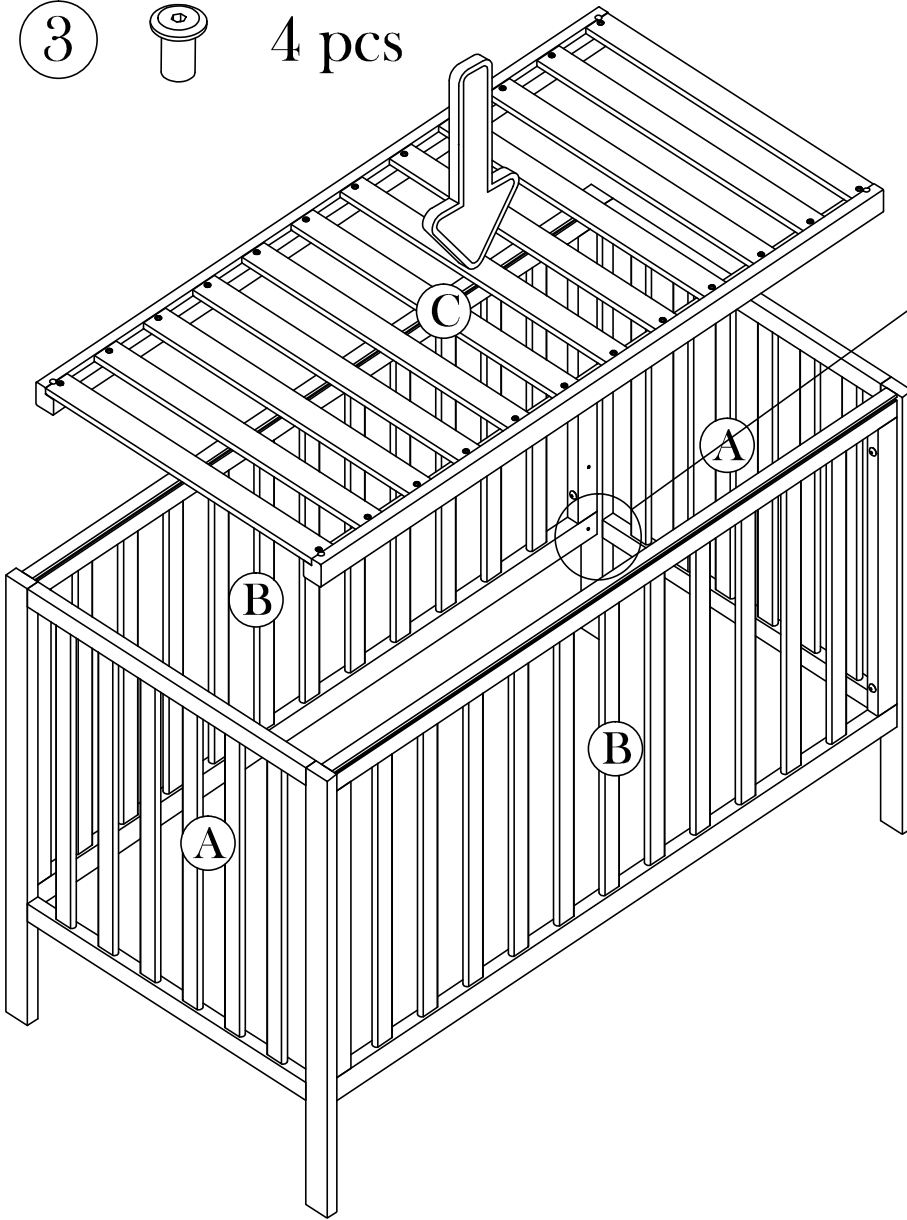

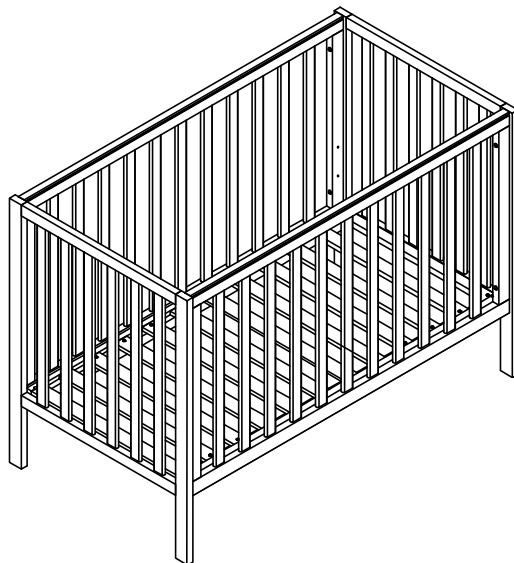
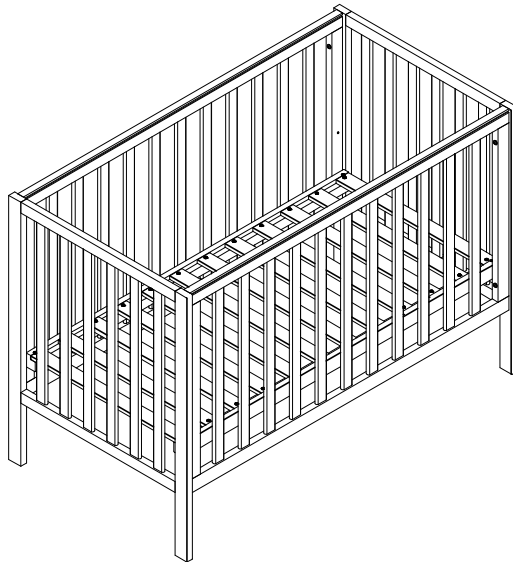
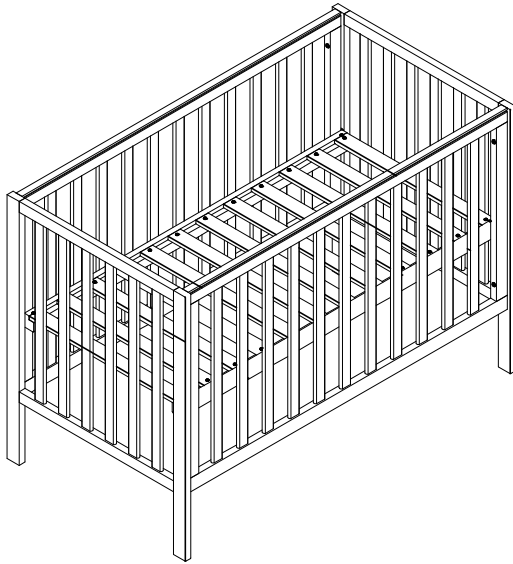

Finish

