

bemodern

FIREPLACES & STOVES | BATHROOM FURNITURE

INSET LED Electric Fire

Model No.2100 / 2606

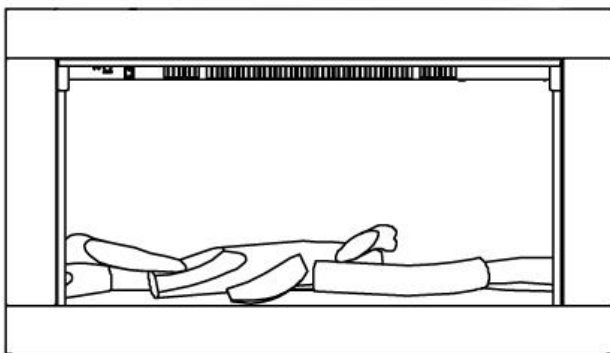

INSTALLATION AND OPERATION INSTRUCTIONS

Please read the instructions carefully before installation or use and keep for future reference.

CONTENTS

1. Important Safety Information.....	1 - 3
2. Technical Specifications.....	4
3. Parts and Hardware.....	5
4. Appliance Dimensions.....	6
5. Installation Instructions.....	7 - 8
6. Operating Instructions.....	9
6a. Manual Control Panel.....	10
6b. Remote Controls.....	11 - 16
7. Maintenance.....	17
8. Guarantee.....	18
9. Others.....	19

1. IMPORTANT SAFETY INFORMATION

- 1.1 **Read all of the instructions carefully before using the appliance.**
- 1.2 **For indoor use only.** This appliance is not suitable for use outside the house and **only suitable for well insulated spaces or occasional use.**
- 1.3 Do not use this appliance in the immediate surroundings of a bath, a shower or a swimming pool.
- 1.4 Do not use this fire as a free-standing appliance. It must always be fixed to the wall, fireplace mantel, floor etc.
- 1.5 This fire must not be located immediately below a socket-outlet.
- 1.6 This appliance must be earthed.
- 1.7 This appliance must not be supplied through an external switching device, such as a timer, or connected to the circuit that is regularly switched on and off by utility in order to avoid a hazard due to the inadvertent resetting of the thermal cut out.
- 1.8 A non-rewirable plug fitted with a 13A fuse is supplied. Should the fuse or plug need replacing, and you are competent to do so, it must be replaced with a 13A fuse or plug being 13A BS1363A approved.
- 1.9 If the power cord is damaged, it must be repaired by the manufacturer, its authorised service centre or professional person.

- 1.10 **Warning:** in order to avoid overheating, do not allow the appliance to be covered or let the air inlet / outlet to become obstructed.
- 1.11 To reduce the risk of fire, keep textiles, curtains, or any other flammable material a minimum distance of 1 meter from the air outlet.
- 1.12 Keep the power cord away from hot surfaces and hot conditions. Do not route the power lead in front of the appliance.
- 1.13 Do not use this fire in rooms that have explosive gas in them (for example petrol), or if you are using solvents, glue, aerosol spray or in flammable paints, as these may catch fire.
- 1.14 This appliance can be used by children aged from 8 years and above and persons with reduced physical, sensory or mental capabilities or lack of experience and knowledge if they have been given supervision or instruction concerning use of the appliance in a safe way and understand the hazards involved.
- 1.15 Children and vulnerable people must be supervised at all times when using this appliance, as some parts can become very hot and cause burns.
- 1.16 Do not use this appliance in small rooms when they are occupied by persons not capable of leaving the room on their own, unless constant supervision is provided.

- 1.17 Cleaning and user maintenance shall not be made by children without supervision.
- 1.18 Children aged from 3 years and less than 8 years only can switch on / off the appliance provided that it has been placed or installed in its intended normal operating position and instructions and supervisions concerning the safe way of the use of the appliance are offered. Children aged from 3 years and less than 8 years shall not plug in, regulate and clean the appliance or perform user maintenance.
- 1.19 This appliance shall not be played with by children.
- 1.20 Children of less than 3 years should be kept away unless continuously supervised.

2. TECHNICAL SPECIFICATIONS

Model No.: 2100/2606

Supply Voltage: AC 230-240V 50Hz

Maximum power consumption: 2KW

Power for flame effect: 2100:20.5W (LED 12.5W + Motor for flame 8W)

2606:25W (LED 17W + Motor for flame 8W)

Heat Output:

Nominal heat output (Pnom): 2KW

Minimum heat output (indicative) (Pmin): 1KW

Maximum continuous heat output (Pmax): 2KW

Auxiliary Electricity Consumption:

At nominal heat output (elmax): 12.5W

At minimum heat output (elmin): 12W

In standby mode (elSB): 0.48 W

Type of heat output / room temperature control

Single stage heat output and no room temperature control	No
Two or more manual stages, no room temperature control	No
With mechanic thermostat room temperature control	No
With electronic room temperature control	Yes
Electronic room temperature control plus day timer	Yes
Electronic room temperature control plus week timer	Yes

Other Control Options

Room temperature control, with presence detection	No
Room temperature control, with open window detection	Yes
With distance control option	No
With adaptive start control	Yes
With working time limitation	No
With black bulb sensor	No



3. PARTS AND HARDWARE

3.1 Unpacking the fire carefully, make sure that the appliance is intact with no signs of damage caused by transport and no part has been exposed to water. If in doubt, do not use the appliance and contact an authorised service centre.

3.2 Keep plastic wrapping away from children.

3.3 Save the original packaging as this may be required in the event of service complaint with product.

3.4 Check that all parts are removed from the packing.

<p>A</p> 	<p>B</p> 	<p>C</p> 
<p>Remote Handset (1)</p>	<p>AAA Battery (2)</p>	<p>Manual Instruction (1)</p>
<p>D</p>		
<p>20 x 10 trim magnets (4)</p>		

4. APPLIANCE DIMENSIONS

Unit: mm

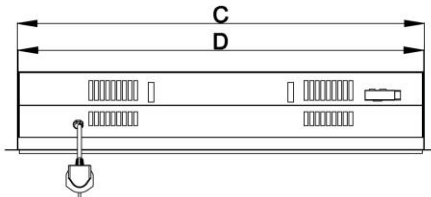
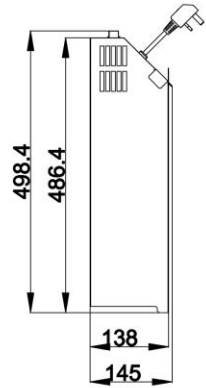
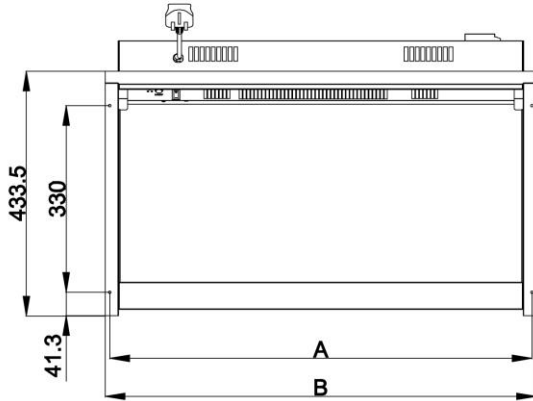

MODEL	A	B	C	D
2100	746.7	762.7	720	717.3
2606	1036.7	1052.7	1010	1007.3

5. INSTALLATION INSTRUCTIONS

Fire Installation

Before You Start

- The appliance Data Plate is located Underneath the Heater box – Disconnect from the mains supply before removing the Glass as described in the maintenance section.
- Required for installation: 4 off screws and plugs suitable for the wall media (Not supplied)
- This fire should not be installed into an open / existing fireplace without the opening being professionally blanked off to reduce the risk of a back draught, which could cause the safety cut-out to operate.
- Check that the supply voltage details on your flame effect fire are in accordance with your electrical supply. Your fire is fitted with a plug incorporating a 13 Amp fuse. In the event of replacing the fuse in the plug supplied, a 13 Amp fuse approved by ASTA to BS 1362 must be used. Before switching on, please read the following fire installation instructions.
- In the event of any problems please contact:
Be-Modern Helpline on 0191 430-0901.
- Fixings supplied (4 off 20 x 10 trim magnets)

Model 2100

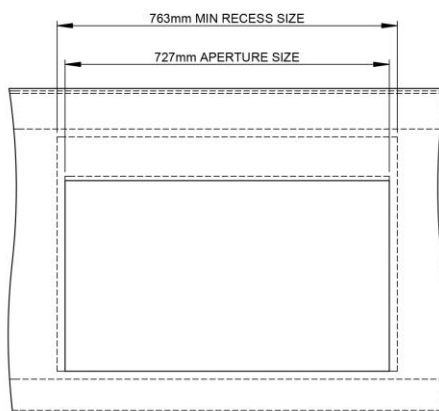
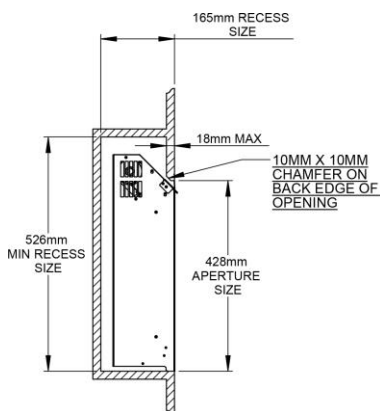

Model 2606

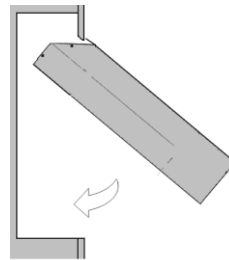
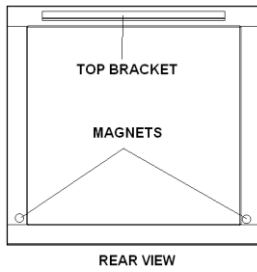
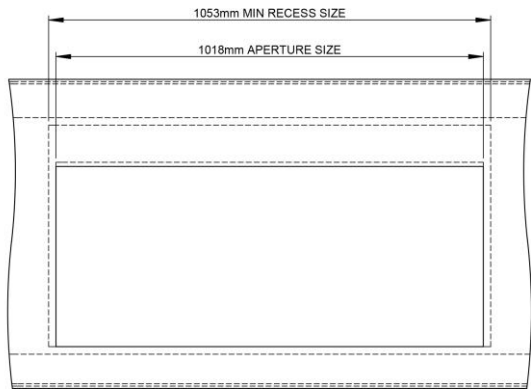
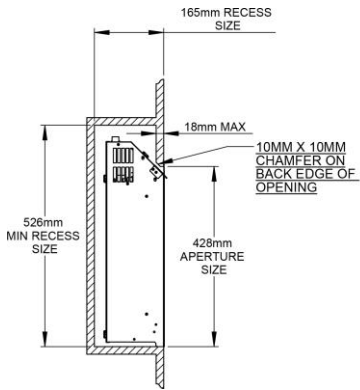

6. OPERATING INSTRUCTIONS

WARNING! Do not operate the appliance if it is damaged or has malfunctioned. If you suspect the appliance is damaged or has malfunctioned call a qualified service engineer to inspect the appliance, and replace any part of the electrical system if necessary, before reuse.

WARNING! To reduce the risk of fire, keep textiles, curtains, or any other flammable material a minimum distance of 1 meter from the air outlet.

MAKE SURE the plug fits tight in the outlet. Faulty wall outlet connections or loose plugs can cause the outlet to overheat.

Do not disconnect the power at the mains supply whilst the appliance is running. Use the functions on the remote to turn the fire off and ensure the mains switch has been moved to the off position before disconnecting.

PREPARATION FOR USE

6.1 The appliance can be operated by both remote control and the manual controls on the appliance.

NOTE: To use either the remote or the manual functions the main on / off switch must be in 'ON' position. In order to prevent the product becoming too hot, there is a 10s delay when turning on the heater and a 10s delay when turning off the heater fan.

Batteries

Ensure that the handset batteries are new and inserted correctly.

Main Power Switch

6.2 The mains power switch is located on the control panel locating on the right-hand side of the heater box.

6.3 Switch ON before operating either the remote or manual controls.

6.4 A long beep is heard to indicate the fire is ready for use.

6a. MANUAL CONTROL PANEL

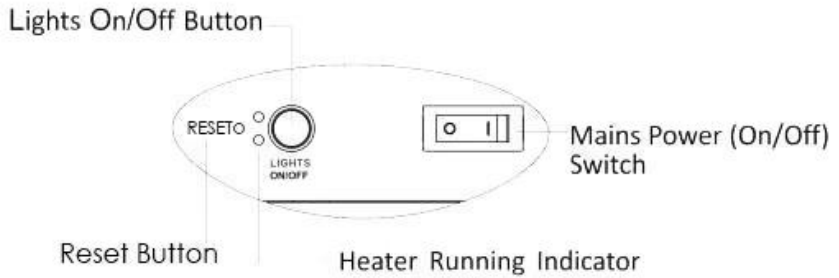

NOTE: The manual buttons control basic functions, not a full range of controls. Use the remote hand set to carry out all functions.

6a.1 The manual buttons are located at the upper right hand-side of the appliance.

6a.2 Press "LIGHTS ON / OFF" to turn on or turn off the flame effect.

When the remote runs out of power or when you change the batteries, the flame function will lose its memory, however this will not affect the timer settings, the clock and date may need to be adjusted.

6b. REMOTE CONTROLS

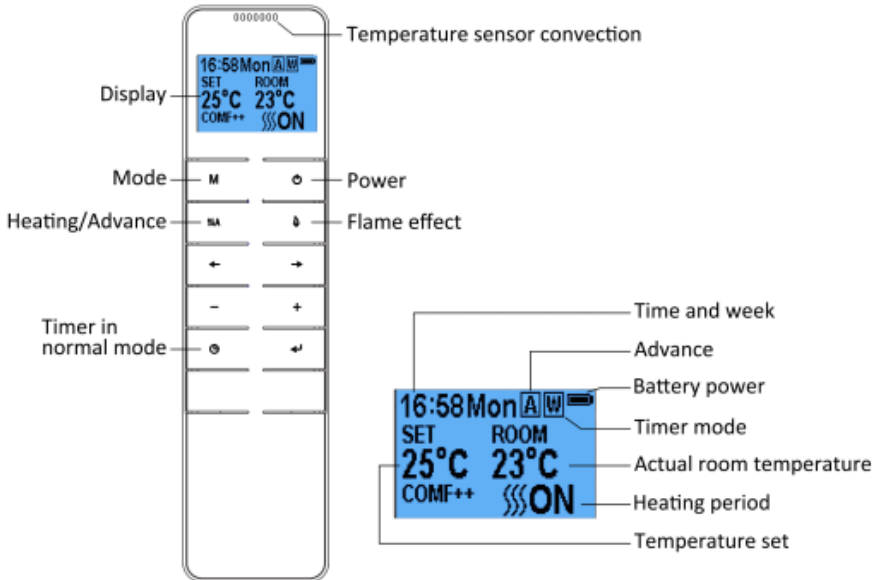

NOTE: This is thermostatic remote control. The remote should be in the same room as fireplace and placed on a flat surface. It must be placed away from the fire so the hot air will not blow on it and affect thermostatic reading.

The communication frequency between the fire and remote has already been set up. If you cannot use the remote with the fire, please follow instructions Step.6b31 to initiate the connection.

Standby for Remote Handset

6b.1 The screen shown to the right is when the remote handset is in standby mode.



Before Day/Time set up

Turn on / off

6b.2 Press  to turn on the flame effect, or turn off flame effect and heater when in normal mode.



After Day / Time set up

6b.3 Press  to turn on / off the flame effect under daily and weekly timer mode.

Flame Effect

6b.4 Press  to enter the flame effect adjustment screen.

6b.5 Press the '←' and '→' button to select the 3 kinds of flame effect.

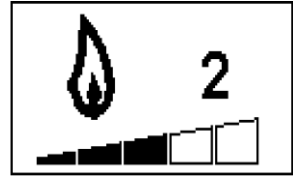



6b.6 Press the '+' and '-' button to select the 5 brightness settings of the flame effect or the OFF setting.

Normal Mode

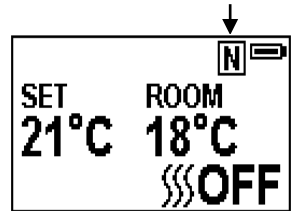
6b.7 Normal control mode is factory set. If it is not, then press **M** button until the logo  shows up at the upper right corner of the screen.



6b.8 Press the '+' and '-' button to adjust the temperature from 17°C to 25°C adjustment is in 2°C intervals.

6b.9 Press  **A** button to turn on / off heat, ON、OFF will show at the lower of the screen.

NOTE: It is normal for the fan heater to stop running for periods of time. This happens because the room temperature is at or above the temperature set on the remote control. The heater indicator will be turned off after 10s if you have the flame ON. The heater indicator will stay ON if you use the heating function only.

Count Down Timer

NOTE: This setting is only for normal mode. It allows the appliance to go into standby after a set period of time.

6b.10 Press  to cycle through the settings from Off and 0.5 hours to 9 hours. The timer logo and time will show on the screen.

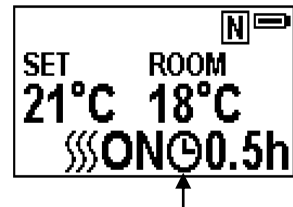

The heater must be in the ON position.

The heater can be automatically run by using daily timer and weekly timer on the remote.

Set up Day, Time and Comfortable temperature.

6b.11 Press  to turn on the remote handset.
Hold the button **M** for 3 seconds to enter the setting screen.

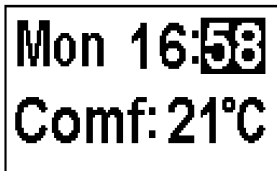

6b.12 Press the '←' and '→' button to choose Day, Time or your comfortable temperature. The character selected will be highlighted.

6b.13 Pressing the '+' and '-' button will adjust the number.

- Time: 24-hour system
- Select your comfortable temperature from 15-25°C.
- Temperature unit: °C、°F

Daily Timer Heating

6b.14 The following are pre-set heating periods, which can be altered if desired

06:00 until 08:30
17:00 until 22:00

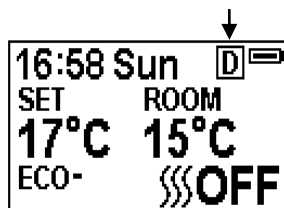

6b.15 Press **M** until  shows at the upper right corner of the screen, then enter the daily timer heating mode.

6b.16 Hold the arrow symbol button  for 6 seconds to enter The daily timer setting. Max 3 timed Heating periods per day.

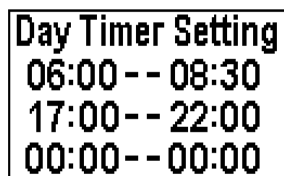

- Press '←' or '→' to choose hour or minute, press '+' or '-' to set the time.
 - Minute will increase / decrease by 15 minutes per press. Hold  for 3 seconds or wait for 10 seconds to save and exit the heating time period setting.

6b.17 Adjusting the set temperature

- Press the '+' or '-' button to increase or decrease the temperature on the basis of your comfortable temperature setting.
- ECO means 2°C lower than your comfortable temperature setting, ECO- means 4°C lower, COMF+ means 2°C higher, COMF++ means 4°C higher.

6b.18 To check your daily timer settings, press ←

6b.19 If the heating needs to be turned off, it will be necessary to go back to the Normal Mode to turn off.

Week Timer Heating

6b.20 The following are pre-set heating periods, which can be altered if desired.

From Monday to Friday

06:00 until 08:30

17:00 until 22:00

From Saturday to Sunday

06:00 until 09:30

11:00 until 13:00

17:00 until 22:00

6b.21 Press **M** until **W** shows at the upper right corner of the screen, then enter the week timer heating mode.



6b.22 Hold ← button for 6 seconds to enter the weekly timer setting.

- Press '←' or '→' to move the cursor (a flashing underline), press the ← button in the corresponding week position to select (the character is highlighted) or cancel (the character is displayed normally) the current setting. Several days can be selected together.
- Press the '→' button to move the cursor to the time period setting area. Press '←' or '→' to choose hour or minute, press '+' or '-' to set the number.
- Max 3 heating periods for a day.
- Minute will increase / decrease by 15 minutes per press.
- Press the ← to set the heating time for the selected day(s) and return to the week line.
- Hold ← for 3s or wait for 10s to save and exit the heating time period setting.

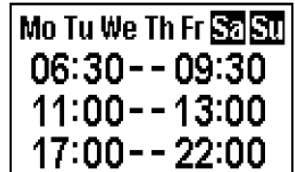
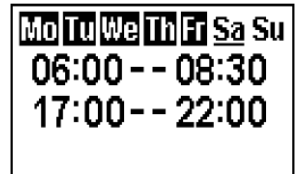

6b.23 Press ←, '←' and '→' to check your week Timer settings.

6b.24 If heating needs to be turned off, it will be necessary to go back to the Normal Control Mode to turn off.

Advance Mode

6b.25 Under the daily and weekly timer mode press **SSS A**:

6b.26 To turn the heater off when the heater is on during a pre-set heating period.

6b.27 To turn the heater on when the heater is off in between pre-set heating periods.

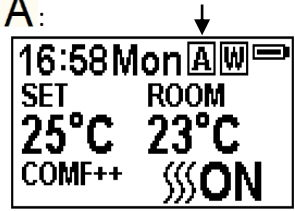

Adaptive Start Control

6b.28 According to room temperature and set temperature, the heater will automatically come on in time to heat the room to the set temperature at the set time. For example, if your timer is set to start at 18:00 and temperature is set to 23°C, the fire will come on at 17:30 to ensure the room is 23°C at 18:00.

Window Open Detection

6b.29 When the transmitter detects a rapid drop in room temperature, it will be judged as a window open, the warning icon will be displayed and the heating will be turned off automatically.



6b.30 After the indoor temperature has risen or a manual override of the warning (by operating remote control) has been done, the fire will return to normal working state.

Set up the communication between the remote and appliance

6b.31 The below operations should be carried out before programming, when changing to a new remote or in the event the appliance cannot be controlled by the remote:

- Hold the reset button on the appliance for 3 seconds (pen Point may be needed) until you hear 3 short beeps from the unit, release the button.
- Press the  button on the remote, the programming is finished when you hear 1 long beep from the appliance.

6b.32 Resetting the code for remote control is necessary if the appliance operates wrongly or the remote control does not operate correctly.

- Open the back cover of the remote control.
- Press the Reset button on remote handset.
- Follow the steps 6b.31



Resetting the Thermal Cut Out

6b.33 This appliance is fitted with an Electronic Safety Control (E.S.). This is a safety device, which switches off the fire if, for any reason, the appliance overheats, e.g. if covered. If the heater stops operating while the flame effect continues working normally, this indicates that the E.S. Control is in operation. The E.S. Control can only be reset after the appliance has cooled down, and the appliance has been reset. Resetting of the E.S. Control proceeds as follows:

6b.34 Switch off the appliance (Manual On / Off switch) and leave it off for approximately 10-15 minutes.

6b.35 Remove any obstruction to the fan heater outlet or fan blades etc. Make sure that the power supply is disconnected with the plug socket outlet while doing this.

6b.36 Switch on the appliance and the E.S. Control will be re-set.

6b.37 Ensure that the appliance is functioning correctly. If the E.S. Control operates again, the appliance should be checked by a competent electrician.

7. MAINTENANCE

WARNING: Before any maintenance or cleaning of the exterior of the fireplace, the unit should be disconnected from the power supply until it has cooled down.

Remote Handset Battery Replacement

7.1 When the batteries are at full power, the battery symbol will show 

7.2 When the batteries are half full, the battery symbol will show 

7.3 When the batteries are out of power and need replacing immediately, the battery symbol will show 

7.4 Battery replacement is recommended after 1 year. The batteries are 1.5V alkaline AAA, batteries.

7.5 Dispose of old batteries at an appropriate recycling facility.

Cleaning the Fireplace

Cleaning or polishing products are not recommended. Fingerprints or other marks on the front glass panel can be removed by a piece of soft, damp, lint-free cloth with a good quality household glass cleaner. The glass is held in position by two glass brackets which are located at the top of the glass on the left and right hand side. The front glass panel should always be completely dried with a clean, lint-free cloth or paper towel.

CAUTION: Abrasive cleaners should not be used on the glass panel. Liquids should not be sprayed directly onto any surface of the unit.

Control PCB	Remote Control Receiver	Remote Control Transmitter
Hardware: RC01-041B01 Software: VI	Hardware: RF290B V1.2	Frequency: ASK/OOK 433.92MHZ Maximum transmit power: 10mW Hardware:RF290A-TX-V1.3 Software: RF290A_C_V0.6.0.hex

Electric Fire Guarantee

Be Modern Group (the 'Company') provide a **twelve month** guarantee in respect of electric fire (the 'Product') ranges.

1. The twelve month Guarantee applies to:

- All 'Products' in the ranges manufactured by the 'Company' (but subject to exceptions below); where
- The 'Product' has been purchased and installed within the UK and in respect of
- The initial installation; and in favour of
- The original Purchaser

2. Proof of purchase must be retained by the Purchaser

3. The twelve month Guarantee does not apply to:

- Damage or inferior workmanship practices while the 'Product' is being installed
- Damage caused by the mis-use of the 'Product' or where normal standards of care and use have not been complied with.
- Damage through a malfunction or an inadequately installed electric fire.
- Damage or defects due to, mis-use, accident or unauthorised alterations.

During the **twelve month** after the 'Product' has been supplied, the Guarantee covers the making good (whether by repair or replacement at the company's option) of defects arising from defective manufacture of materials of 'Product' covered in paragraph (1), all at no cost to the Purchaser.

This Guarantee does not affect your statutory rights

On requiring service contact the retailer who supplied your product who will assist you and advise you as necessary.

Be Modern Ltd.
19/34 Bedesway,
Bede Industrial Estate,
Jarrow,
Tyne and Wear
NE32 3BE
Tel: (0191) 430 0901
Fax: (0191) 430 9522
<http://www.bemodern.com>

8. OTHERS

Environment

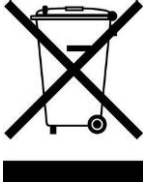

Meaning of crossed –out wheeled dustbin:

Electrical appliances should not be disposed of as unsorted municipal waste. Separate collection facilities should be used in the disposal of electrical appliances. Contact your local government for the information about the available collection systems. If electrical appliances are disposed of in landfills or dumps, hazardous substances can leak into the groundwater and get into the food chain, damaging your health and well-being. When old appliances are replaced by the new ones, it is a legal obligation for the retailer to take back the old appliance for disposals at least free of charge.



This fire complies with the Safety Standards EN 60335 1 and EN 60335 2-30 which covers the essential requirements of the Low Voltage Directive 2014/35/EU and the EMC standards EN 55014-1; EN 55014-2; EN 61000-3-2 and EN 61000-3-3 which covers the essential requirements of the European Electro Magnetic Compatibility 2014/30/EU, and the RED standards EN300220-2, EN301489-1, EN301489-3 and EN6247 which covers the essential requirements of The European Radio Equipment Directive 2014/53/EU.



This fire complies with the Safety Standards BS 60335-1 and BS 60335 2-30 which covers the essential requirements of the Electrical Equipment (Safety) Regulations 2016 and the EMC standards BS 55014-1; BS 55014-2; BS 61000-3-2 and BS 61000-3-3 which covers the essential requirements of the Electro Magnetic Compatibility Regulations 2016, and the RED standards BS 300220-2, BS 301489-1, BS 301489-3 and BS 6247 which covers the essential requirements of the Radio Equipment Regulations 2017.



RoHS stands for Restriction of Hazardous Substances, and impacts the entire electronics industry and many electrical products as well. The Restrictions of the Use of Certain Hazardous Substances in Electrical and Electronic Equipment Regulations 2012, originated in the European Union in 2002 and restricts the use of six hazardous materials found in electrical and electronic products. All applicable products in the EU and UK market since July 1, 2006 must pass RoHS compliance.