

Cleaning

All chrome surfaces should be cleaned using a clean damp cloth.

No abrasive cleaning agents or materials should be used.

General glass cleaner can be used for the screen, but ensure that this will not damage the chrome, check the cleaning information on the product before use.

This instruction will cover installation of the following units

Codes:

8070, 8399, 8474, 9927

8070 - Adjustment between 720 - 760mm

8399 - Adjustment between 860 - 900mm

8474 - Adjustment between 760 - 800mm

9927 - Adjustment between 660 - 700mm

Telephone
0333 777 4777

Aquafloe Pivot Door



Please retain this manual after installation for future reference and maintenance.

Images are for installation purposes only.



IMPORTANT

Handle with care, impact can damage both the glass and frame

Check for pipes and wires prior to drilling

Use of safety equipment is advised

Two people may be required for parts of the installation

If installing on a tray, follow correct method of installation by installing the tray and tile down onto this.

Parts		
Part	Qty	Description
1		Wall plug
2		Screw cup
3		Wall screw M4 x 25
4		Screw cover
5		Wall channel/Side profile screw M4 x 10
6		Wall channel
7		Side profile
8		Vertical seal
9		Hinge assembly *
10		Top profile
11		Bottom seal
12		Bottom profile
13		Vertical magnetic strip (Pre-fitted to door)
14		Door
15		Handle
16		3mm drill bit

* Assembly includes, chrome glass bracket, plastic hinge pivot, screw cups, screw covers and glass gasket

* You also receive 4 dark grey plastic clips, these are spares for the magnetic strip

Tools

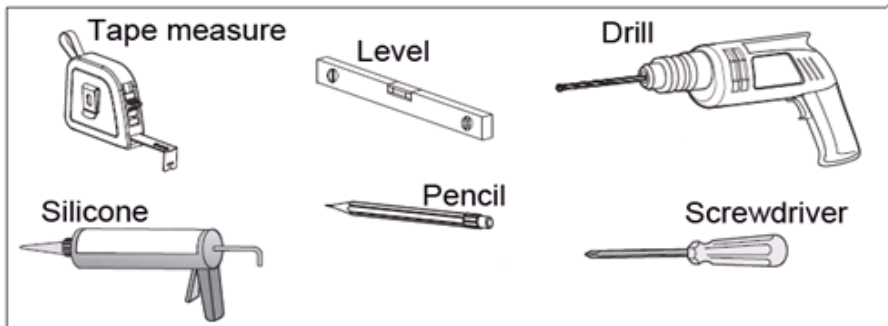

Parts

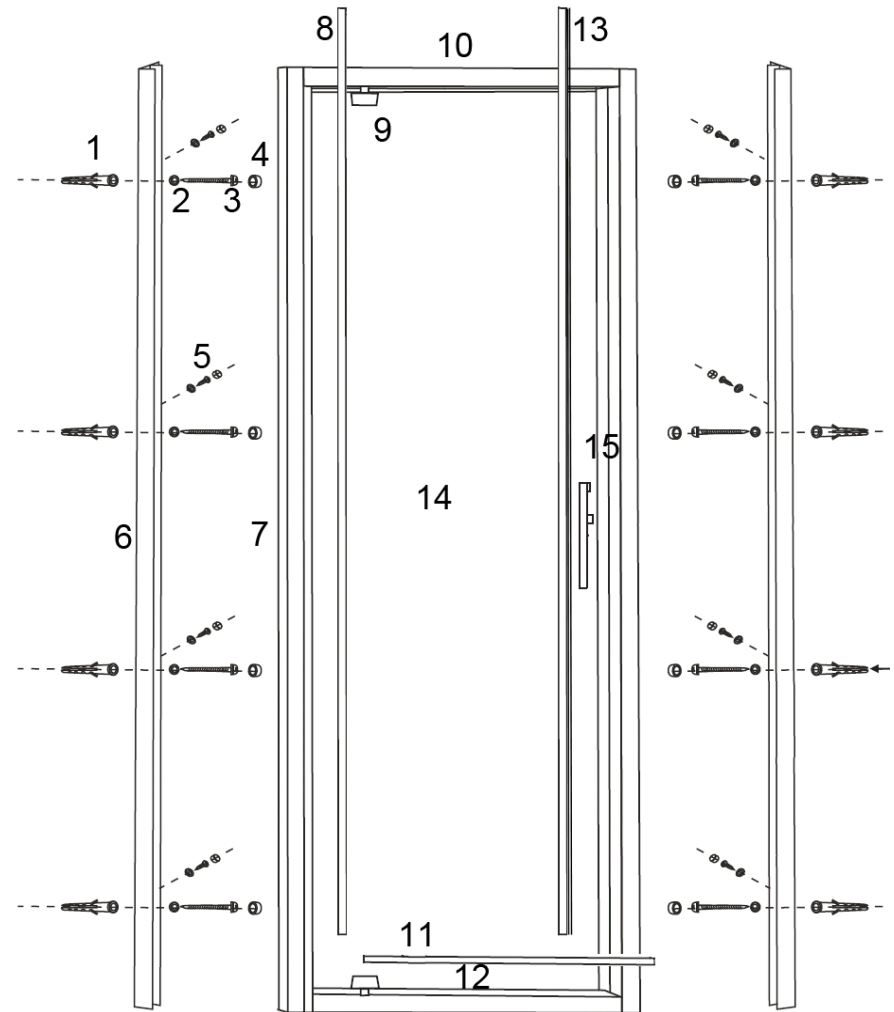

Part 10&12 --Top & Bottom rail length
 700 Enclosure - 590mm
 760 Enclosure - 650mm
 800 Enclosure - 690mm
 900 Enclosure - 790mm

Installation - Step 1

Place the wall channel on the tray approx 10-15mm in from the front edge of the tray.
Using a level ensure the channel is vertical.
Mark the drill holes on the wall through the wall channel lip, to the side of the main channel.
Carry out the same process for both wall channels
Alternatively you can push the door frame into both wall channels then place this onto the tray and mark the holes.

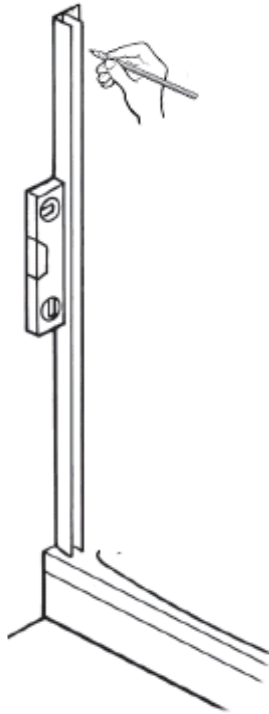
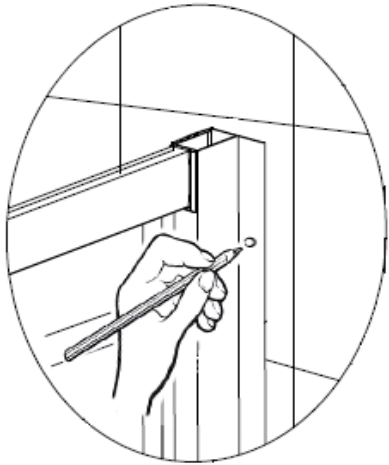

View from above

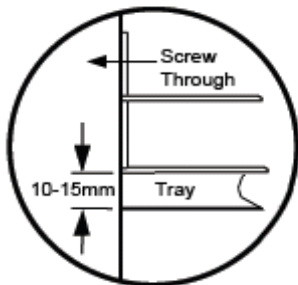

Installation - Step 2

Once the wall has been marked, remove the assembly and drill the wall using suitable drill bit for your wall type.

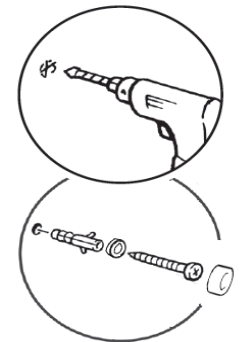
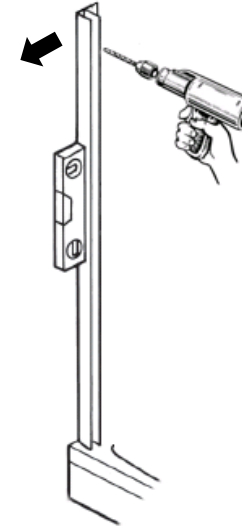

After drilling, insert wall plugs and tap in so flush with finished wall.
Hold one wall channel against the wall over the drill holes
Screw the wall channel to the wall ensuring to fit washer onto screw M4 x 25, to allow fitting of the screw cover.

NOTE: Sealant can be applied between the wall channel and the wall.

NOTE: Depending on your recess size a different method of assembly may be required, or the next step.

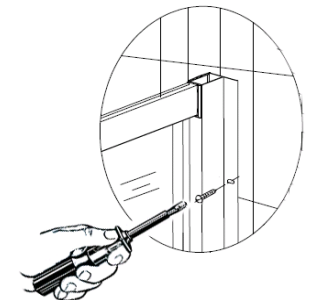

Installation - Step 3 (Option 1)

Fitting the second wall channel and door frame, will depend on the size of the recess in which the assembly is being fitted.

If the size allows, you can secure the second wall channel to the wall, then:

Slide into one wall channel (1), push back (2), then across into the other channel (3)

Position as required within the channels.

Ensure the door frame is level.

Drill the wall channels and profile from the inside, **do not drill through to the outside of the wall channel.**

Secure into position using screws M4 x 10, ensure to fit screw cups

Finally push on screw covers

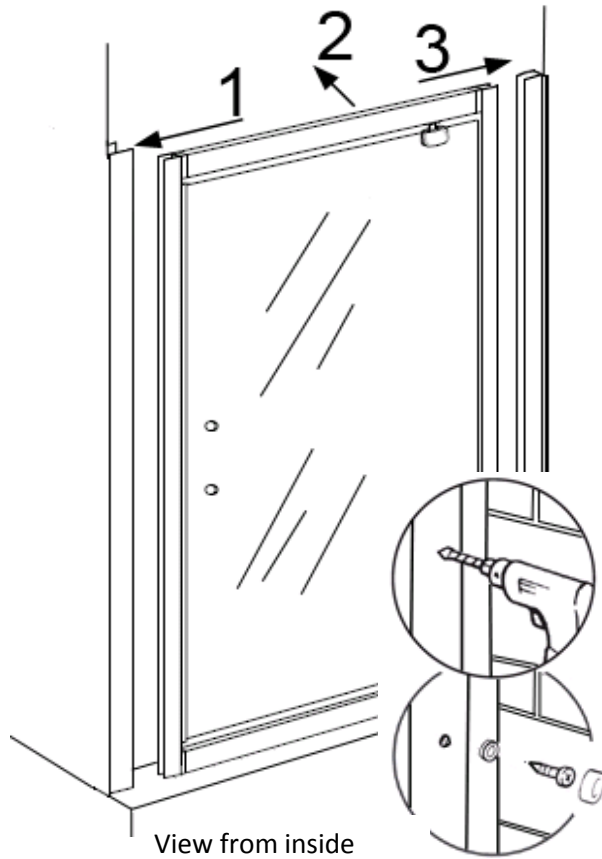

Installation - Step 3 (Option 2)

If the recess in which the assembly is being fitted does not allow for Option 1, the following process should be used.

Slide the wall channels onto the frame, then place this onto the tray over the drill holes.

Secure the wall channels to the wall in the same way as Option 1.

Then drill the wall channel and frame and secure in the same way as in Option 1

Installation - Step 4

Push the plastic pivot into the inside of the top and bottom profile over the pre-drilled holes

Secure this into position using the M4 x 25 screws, cups and covers.

Place the chrome glass bracket into the pivot with the screws facing inwards.

Once both the top and bottom hinges have been fitted and secured, position the hinges to allow the door to be pushed into the hinge bracket.

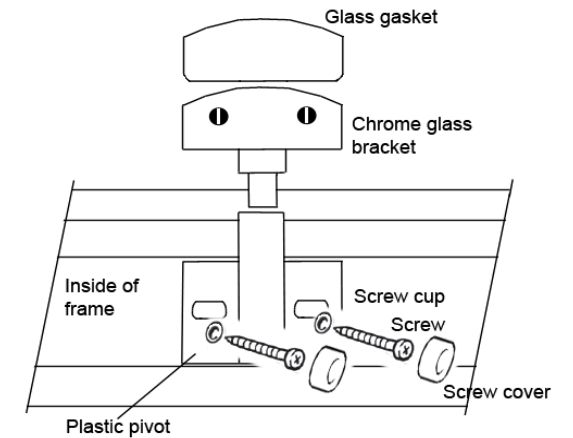

Installation - Step 5

Ensure the glass gaskets are fitted inside the brackets to the outer edge

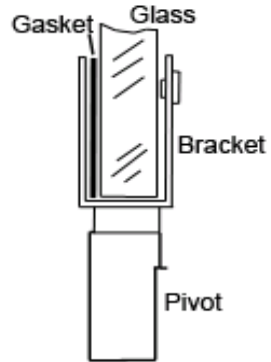

Push the door into the top and bottom hinge and align so that the door closes correctly.

Once positioned tighten the bracket screws onto the glass.

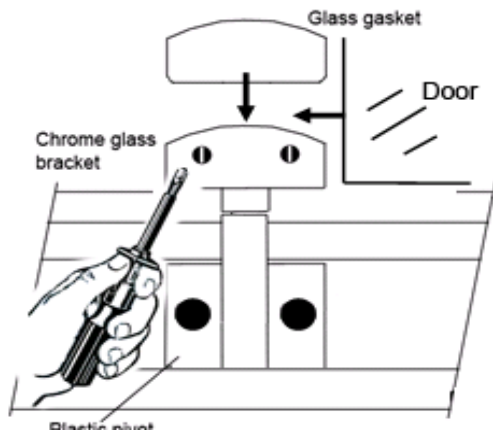

Installation - Step 6

Push the long vertical seal onto the door. Then cut to length if required.

The bottom seal will need to be cut to accommodate the pivot.

Ensure that the seal butts up against the pivot to create a seal.

Also ensure that the vertical seal and bottom seal meet to create a joint.

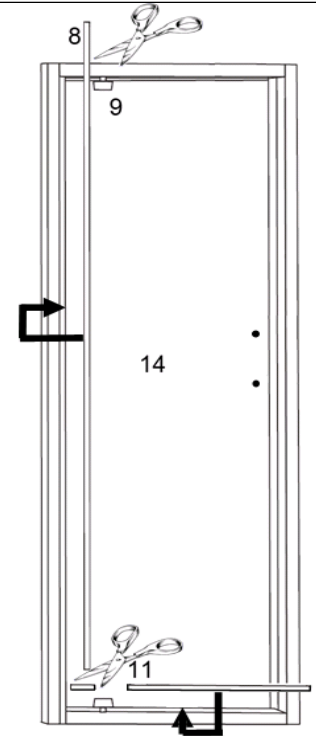

Installation - Step 7

Offer the door handle to the outside of the door. Placing washers between the handle and the glass. From inside fit the screws through the holes in the glass, ensuring again to fit the washers. Tighten the screws to secure the handle. Do not over tighten.

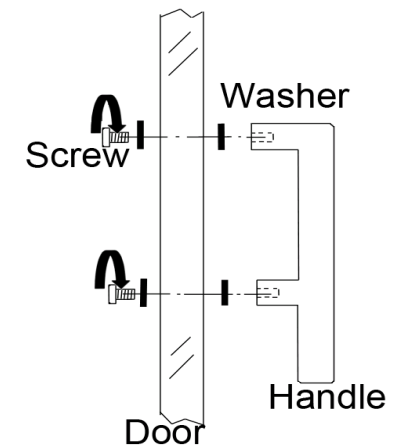

Installation - Step 8

Sealing should be carried out along the bottom outer edge of the frame and up the outside of the wall channels.

DO NOT seal on the inside of the enclosure.

After sealing do not use the enclosure for at least 24 hours

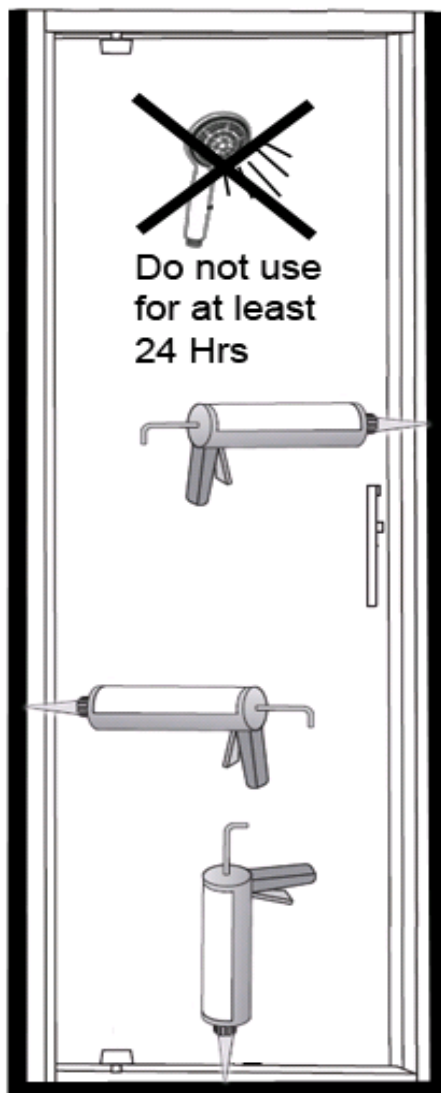

Guarantee

Not covered by the guarantee is:

- Breakdown due to -
 - a) Use other than domestic
 - b) Wilful act of neglect
 - c) Any malfunction resulting from incorrect use
 - d) Incorrect assembly/installation
- Repair costs for damage caused by foreign objects or substances
- Total loss of the product due to non-availability of parts
- Compensation for loss of use of the product or consequential loss of any kind.
- Call out charges where no fault has been found with the product.
- The cost of repair or replacement of any accessories installed at the same time.
- The cost of routine maintenance, adjustments, overhaul, modifications, loss or damage, arising therefrom, including the cost of repairing damage, breakdown, malfunction caused by incorrect use, assembly or maintenance

Part	Part No.	Qty
A1	P0029-2	2
A2	P0019-2	10
A3	P0002-6	10
A4	P0002-8	10
A5	N/A	1

B1*

B2 P0002-9 10

C1*	P0013-8	4mm	4
	P0013-7	6mm	4

D1*

D2	P0041-1
D3	P0001-8
D4	P0041-2
D5	P0001-9
D6	P0036-2
D7	P0042-1

E1*

E2*

E3	P0034-2	
E4	P0002-8	
E5*	P0013-8	4mm
	P0013-7	6mm

*Dependant on screen purchased