

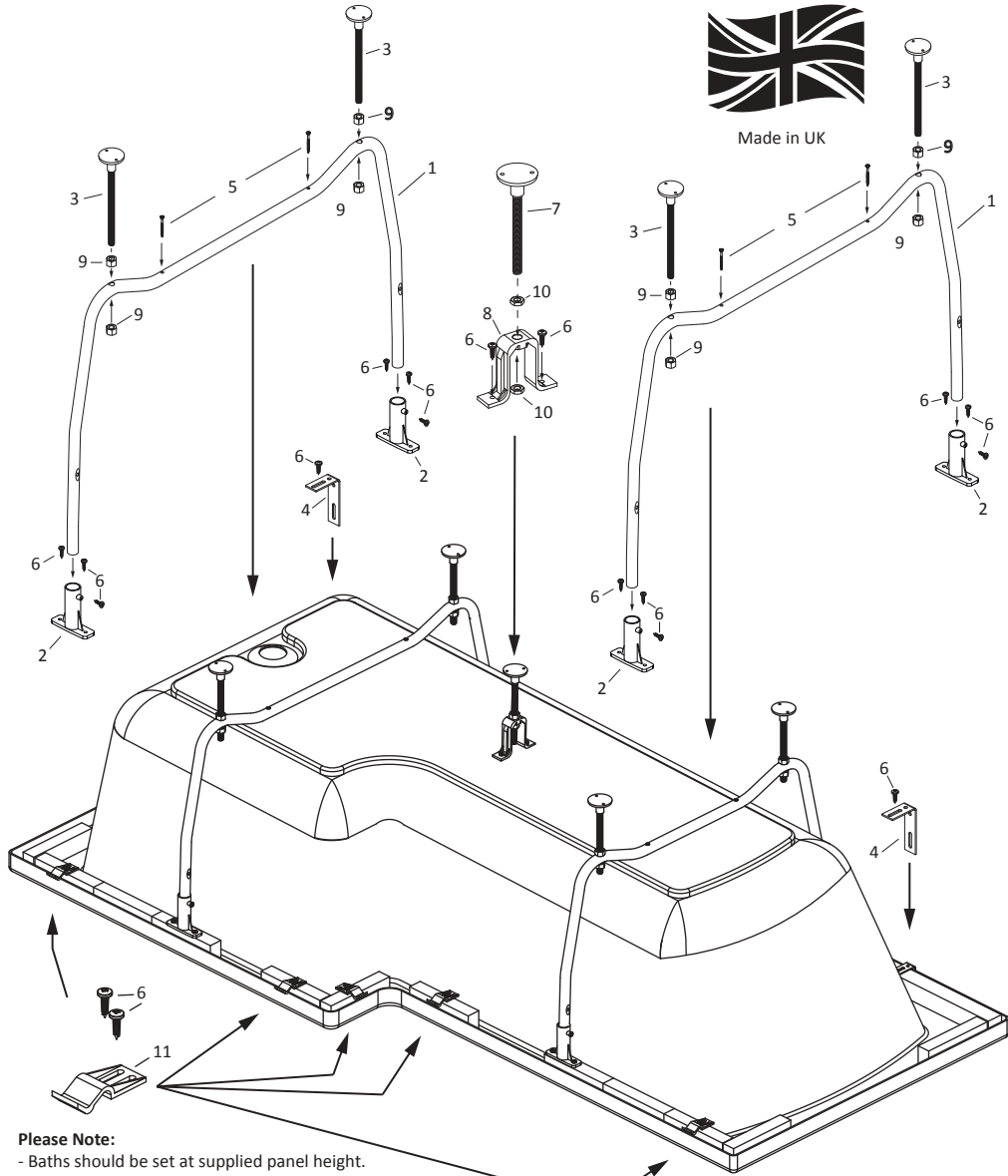

Made in UK



Please Note:

- Baths should be set at supplied panel height.
- The baseboard is encapsulated into the bath.
- Remove the two tubular cradles from the bath.
(Retain the transit cradle fixing screws No'5 Qty 4)
- Align the cradle and hand screw directly into the base of the bath using the **32mm** transit cradle fixing screws.
(Important! YOU MUST CHECK THE SCREW LENGTH FIRST)
- Half the panel clips supplied should be secured (if possible) to the floor.
- Before the final fixing of the bath, fit tap and waste fittings using a suitable sealing compound. When complete place the bath into position, re-check levels and make any final adjustments necessary. Finally secure the feet to the floor and the wall brackets to the wall. Movement may occur if not fitted correctly.
- CHECK THAT THE BATH RIM IS LEVEL.

V1/110518
1031

Quality Acrylic Baths

Manufactured in the UK

1500/1700 L Shaped Bath Installation Instructions

- Read through the instruction booklet first before commencing any work. If you are unsure of any aspect of the installation, we recommend you contact a reputable tradesperson.
 - Prior to fitting your bath, carefully remove all the packaging and film from the bath and examine the bath for damage and suitability of colour match.
 - Check the panel fit and match prior to installation.
 - Any refixing costs or claims for wrong colour match and/or any other fault will not be accepted after fixing.
- No claims for the above will be accepted once the bath is fitted.**

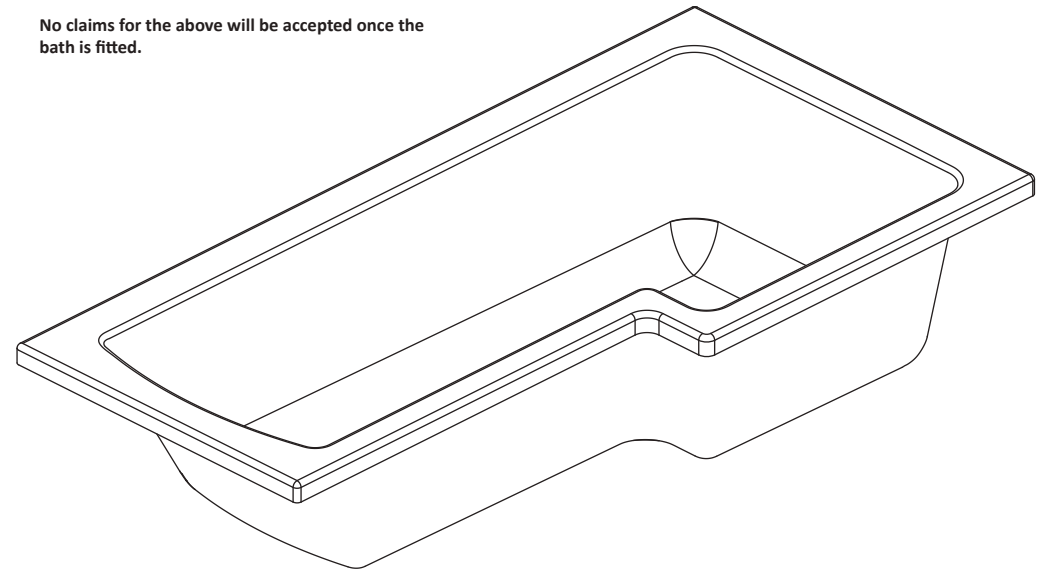

Please note, 1700 bath shown is for illustrational purposes.

25
Year
Guarantee

1500/1700 L Shaped Bath

Installation Instructions

Before you start

- Before fixing remove ALL protective covering and examine carefully. The polythene film must be removed in full and the bath checked for any visible damage.
- Unpack and check the product is complete and undamaged.
- Have the correct tools available.
- Please notify the retailer immediately of any damage or faults. The manufacturer cannot be held responsible for any installation costs that may arise from damaged or faulty product being installed. The guarantee does not cover impact related damage. Please dispose of all packaging with due regard to the environment.

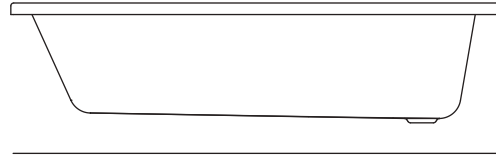

Safety

- Handle the bath with care.
- This product is heavy and requires two persons to carry.
- When drilling walls, check first for hidden pipes and cables.
- Use safety eyewear when drilling.
- Keep small parts away from children.

Tools required

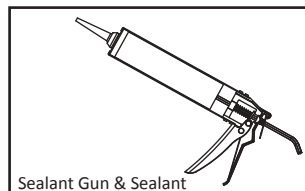
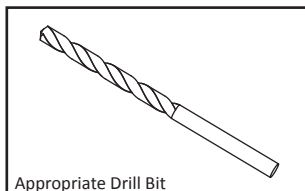
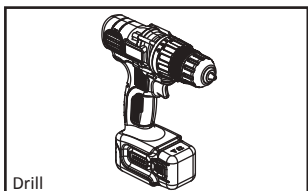
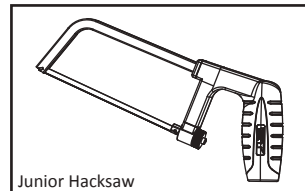
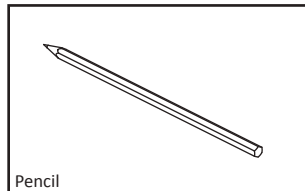
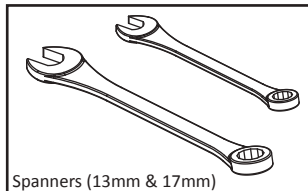
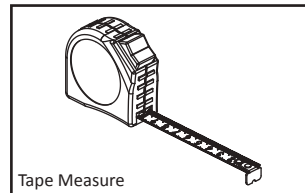
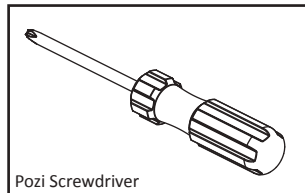
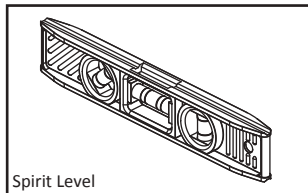

*Tools shown not supplied
 *Ensure drill bit used is suitable for wall surface!

V1/110518
 1031

Parts provided

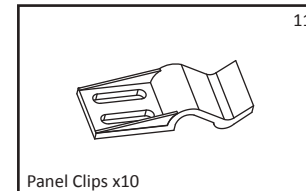
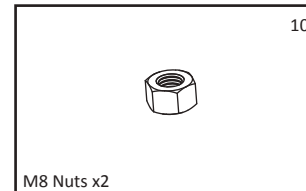
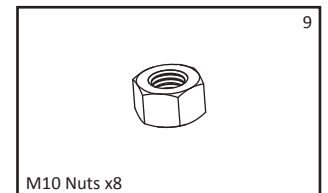
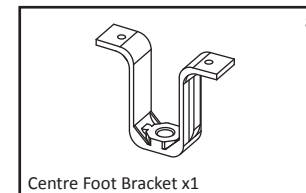
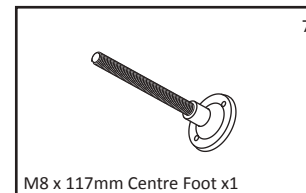
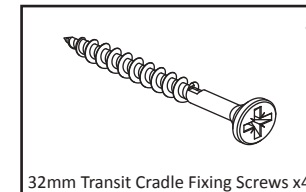
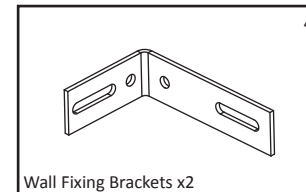
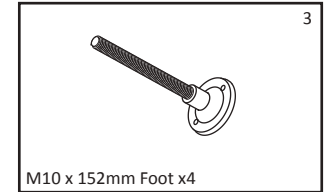
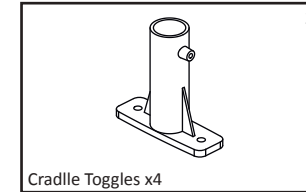
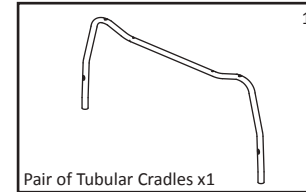

- We have taken great care to ensure that this product reaches you in perfect condition. However should any parts be damaged or missing please contact your point of purchase. This does not affect your statutory rights. In addition if you require replacement parts your point of purchase will be happy to assist.

- Please discard any additional spare parts with due regard to the environment.