

FLEXI-FIX WALL MOUNTED MIRROR

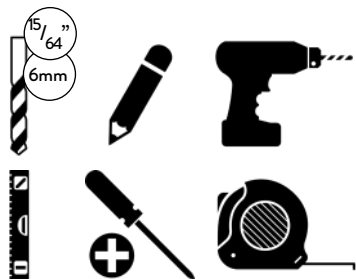

FIXING PACK CONTENTS

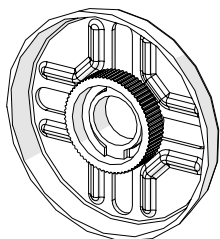
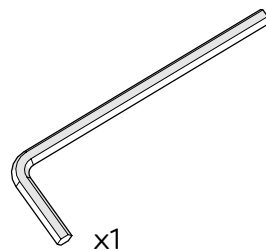
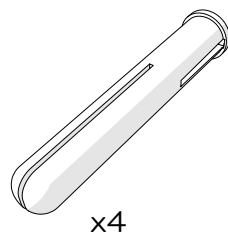
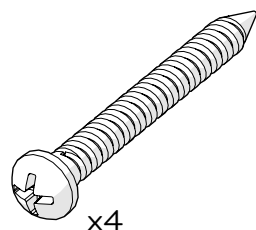
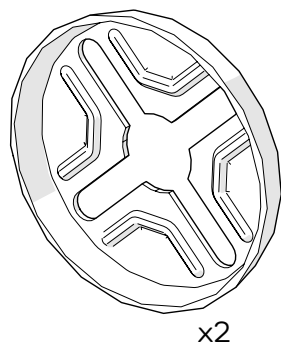

SAFETY AND CARE

1. Always take care when using power tools, particularly if there is any water in the working area.
2. Always check for hidden cables and pipework before drilling and take extreme care if there is any water in the working area.
3. Always use a residual current circuit breaker (RCCB/GFCI).
4. Always wear suitable eye protection when drilling.
5. When drilling into a tiled surface do not use a hammer drill.
6. Always use a drill bit that is suitable for the surface that is being drilled.
7. The wall plugs supplied are for use on solid walls only. For cavity walls or plasterboard use specialist fixings that are suitable for the type of wall construction.
8. To retain the best quality finish, clean product regularly with a soft damp cloth.
9. Do not use abrasive or chemical cleaners, as these may damage the product.
10. Redecoration may be required on some painted surfaces after removal.
12. Do not position glass products directly above a heat source.

When drilling new holes.

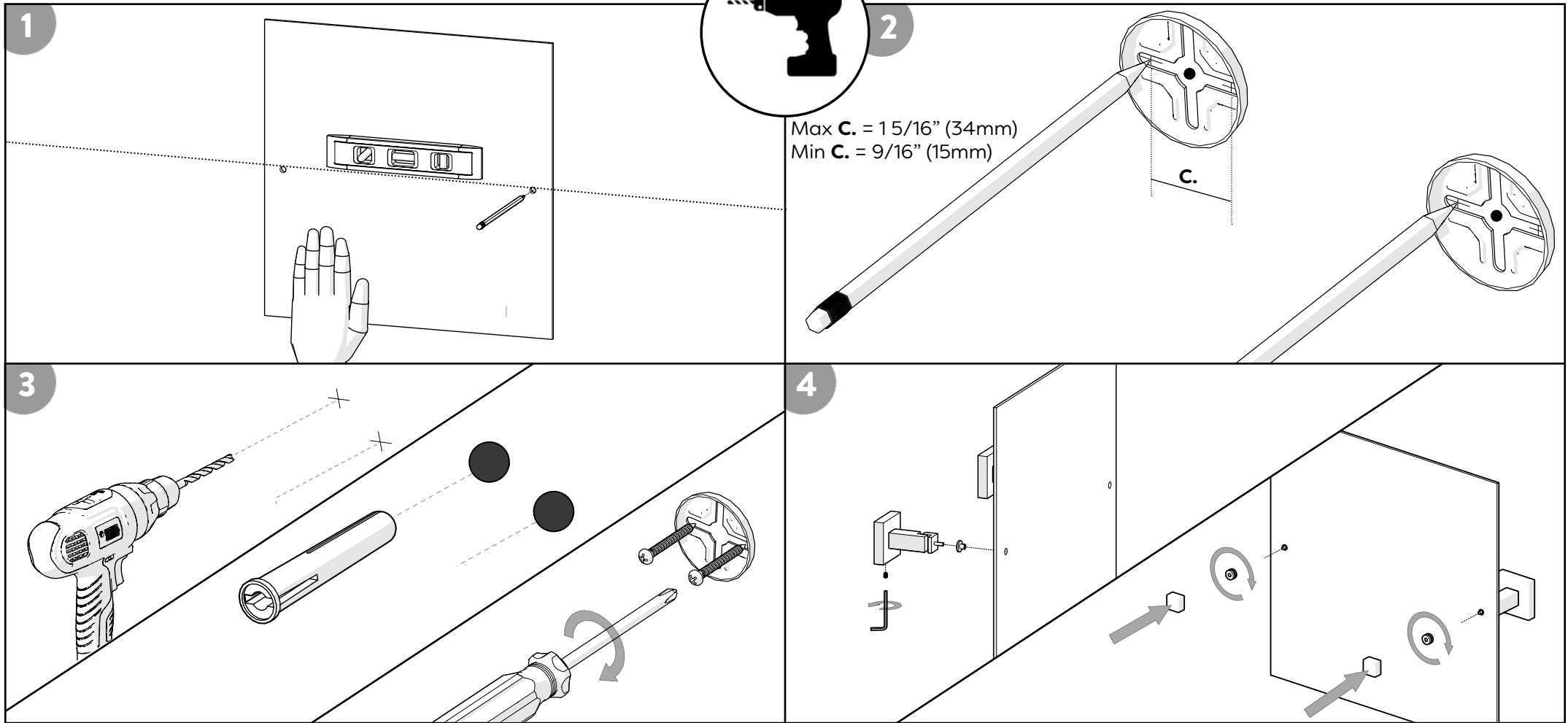

Croydex, Central Way, Andover,
Hampshire, SP10 5AW, UK
EU: MIL, Unit 8 Purcellsinch
Ind Est, Dublin Road, Kilkenny,
R95 HP71, Ireland



+44 (0) 1264 365881



+44 (0) 1264 356437



info@croydex.co.uk



www.croydex.com

WMA 110 R04

