

## USER MANUAL

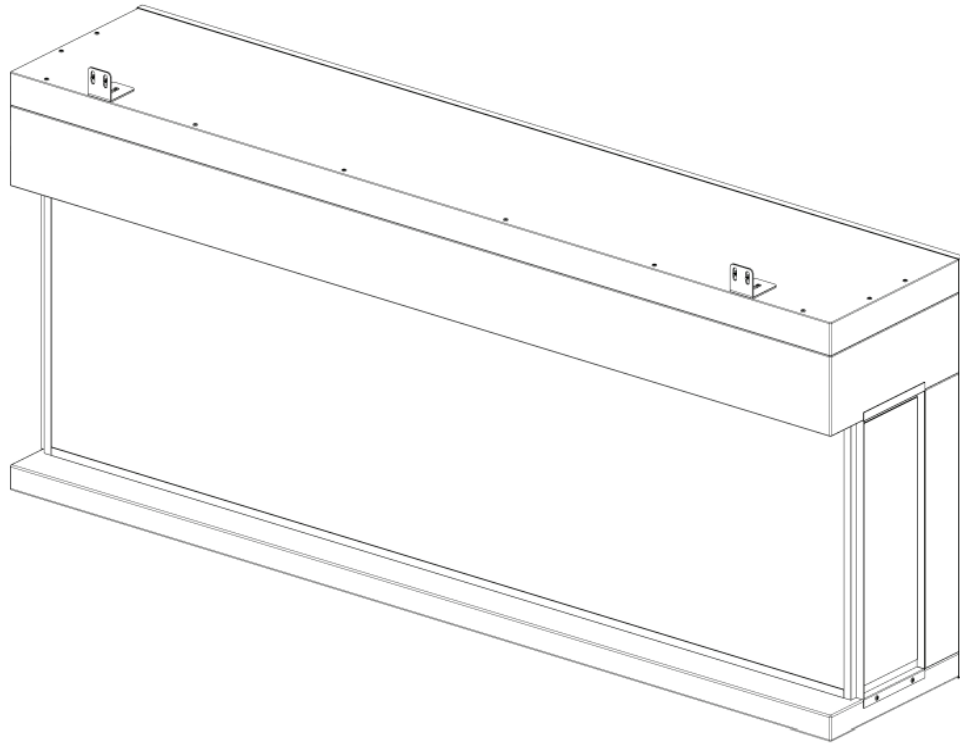

## MEDIA WALL ELECTRIC FIREPLACE

<b>AGL073</b>	<b>40 Inch</b>
<b>AGL067W</b>	<b>50 Inch</b>
<b>AGL068W</b>	<b>60 Inch</b>
<b>AGL069W</b>	<b>70 Inch</b>

Thank you for choosing this electric fireplace.  
Please read this manual before using or installing this electric fire  
and keep it safe for future reference.

# CONTENTS

SAFETY	2
PARTS SUPPLIED	5
BEFORE INSTALLATION	6
MEDIA WALL REQUIREMENTS	7
PREPARING THE FIRE FOR INSTALLATION	8
INSTALLATION	10
OPERATION	12
CARE AND MAINTENANCE	14
SUPPORT	15
TECHNICAL SPECIFICATIONS	15
PRODUCT FICHE	15

## SAFETY INFORMATION

When using electrical appliances, basic safety precautions should always be followed, including the following:

- **IMPORTANT:** Read all instructions and warnings carefully before starting installation. Failure to follow these instructions may result in a possible electric shock or fire hazard and will void the warranty.
- Before connecting the appliance, be sure that the main voltage available matches what is specified on the rating label and that the outlet is suitably grounded.
- The appliance must be installed in a place which is in line with national regulations concerning the discharge of air.
- Do not cut, notch or damage any joist, beam or rafter when installing the appliance.
- Children of less than 3 years should be kept away unless continuously supervised.
- Children aged 3 and under shall only switch on/off the appliance provided that it has been placed or installed in its intended normal operating position, they have been given supervision or instruction concerning the safe use of the appliance, and they understand the hazards involved. Children aged 3 and under shall not plug in, regulate, clean, or perform user maintenance on the appliance.
- **CAUTION**—Some parts of this product can become very hot and cause burns. Particular attention must be given where children and vulnerable people are present.
- **WARNING:** In order to avoid overheating, do not cover the heater.
- The heater must not be located immediately below a socket outlet.
- **CAUTION:** To avoid a hazard caused by the inadvertent resetting of the thermal cut-out, this appliance must not be supplied through an external switching device, such as a timer, or connected to a circuit that is regularly switched on and off by the user or utility.
- Do not attempt to repair, disassemble or modify the appliance. This unit contains no user-serviceable parts.
- Ensure the plug is accessible after installation to disconnect the unit from all power.
- Always unplug or disconnect the appliance from the mains power supply when not in use or when moving or cleaning it. Do not pull the cord to unplug the heater.
- Keep the heater clean. Do not allow any object to enter the ventilation or exhaust opening, as this may cause electric shock, fire, or damage to the heater.
- Do not use the appliance for other than its intended use. It is designed for domestic indoor use only.

- There may be a trace of odour during the first few minutes of initial use or after a storage period. This is normal and will quickly disappear.
- If the glass is damaged, do not use the heater in order to avoid a hazard.
- Avoid the use of an extension cord, as the cord may overheat and cause a risk of fire.
- This fireplace is hot when in use. To avoid burns, do not let bare skin touch exposed hot surfaces.
- Keep combustible materials, such as furniture, pillows, bedding, papers, clothes, and curtains, at least three feet from the appliance's exposed areas.
- This appliance is designed for indoor use only and is not intended for use in bathrooms, laundry areas and similar indoor locations. Never locate this appliance where it may become water exposed.
- Do not run the cord under carpeting, cover it with throw rugs, runners, or similar, and ensure it is kept away from traffic areas and in a position that would not present a trip hazard when positioning it during installation.
- To disconnect this appliance, turn the controls off, then remove the plug from the outlet.
- This appliance has hot and arching or sparking parts inside. Do not use it in areas where gasoline, paint, or any flammable liquids are used or stored.
- This appliance should not be used to dry clothing, nor should Christmas stockings or decorations be hung on or near it.
- This electric fire is an instant heat source to warm a room and is great for visual room ambience. It doesn't necessarily need to be used as a constant or permanent home heating source.
- If a television or other electrical device is above this fireplace, the installers must ensure that the ambient temperature around the television does not exceed manufacturers' recommendations.
- Clean the fire regularly to prevent the build-up of hairs, dust, or lint from entering the structure and causing a blockage.
- Do not use aerosols or steam cleaners on or around the fire.
- The fire should be tested before installation.
- We always recommend employing an experienced, qualified installer when fitting such products. Each installation will vary, and specialist expertise is often required to conduct the necessary building work. Buy It Direct, therefore, bears no responsibility or liability for any poor workmanship or incorrectly installed fires and/or fireplaces.



**THIS SYMBOL MEANS DO NOT COVER IN ORDER TO AVOID OVERHEATING. DO NOT COVER OR OBSTRUCT ANY OF THE HEAT OUTLET GRILLES OR AIR INTAKE OPENINGS OF THE HEATER.**

## MANUAL HANDLING

- One person should be sufficient to lift the heater. If, for any reason, it is considered too heavy, then obtain assistance.
- When lifting, always keep your back straight. Bend your legs and not your back.
- Avoid twisting at the waist. It is better to reposition your feet.
- Avoid upper-body/top-heavy bending. Always bend from the knees rather than the waist.
- Do not lean forward or sideways while handling the heater.
- Always grip with the palm. Do not use the tips of your fingers for support.
- Always keep the heater as close to the body as possible. This will minimise the cantilever action.
- If required, use gloves to provide additional grip.
- Always use assistance if required.

## ELECTRICAL SAFETY

The heater must not be located under an electrical socket; the socket must always be accessible in order to disconnect the heater from the electrical supply for maintenance and cleaning.

- **IMPORTANT:** This heater must be earthed. The mains supply must be safely routed to an electrical socket from the heater.
- If the supply cord is damaged, it must be replaced by the manufacturer, service agent or a similarly qualified person in order to avoid a hazard.
- This appliance is supplied with a BS1363 3-pin plug fitted with a 10-amp fuse. If the fuse requires replacement, it must be replaced with a fuse rated at 10 Amps and approved to BS1362.
- In the event the mains plug has to be removed or replaced for any reason.

**NOTE:** The wires in the mains lead on this appliance are coloured in accordance with the following code:

- **Green and Yellow** - Earth
- **Blue** - Neutral
- **Brown** - Live

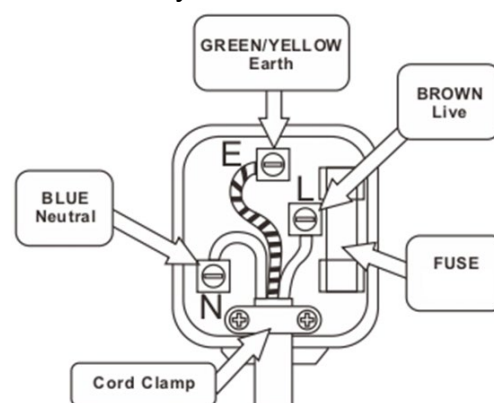







If the wires do not match the colour coding above, please follow the below.

- The green and yellow wire must be connected to the terminal, which is marked with the letter E or with the earth symbol. This colouring will not change.
- The blue wire may be black and must be connected to the terminal marked N.
- The brown wire may be red and must be connected to the terminal marked L.

**IMPORTANT:** Any cut-off plug should be disposed of safely to prevent a hazard. There is a danger of electric shock if a cut-off plug is inserted into a socket outlet.

# PARTS SUPPLIED

**NOTE:** Pictures and contents in this manual may differ from the product due to continuous product improvement.

PART	DIAGRAM	DESCRIPTION	QTY
A		L-shaped bracket	2 PCS
B		M5x10 screw	2 PCS
C		M4X14 screw	4 PCS
D		Logs	AGL073 – 12 PCS AGL067W - 16 PCS AGL068W - 20 PCS AGL069W - 24 PCS
E		Shakeproof washer	2 PCS
-		Remote Control	1
-		Glass Suction Cup	2 PCS

# BEFORE INSTALLATION

**NOTE:** Two people are recommended for installation.

There are multiple ways to personalise the look of your media wall fire, which should be considered before installation.

**IMPORTANT:** Always measure the fire you have received for the installation dimensions, as these may change due to product development.

## SIDES:

These fireplaces are provided with side covers, giving you the option of either displaying the sides of the fireplace within your media wall or covering them within it:

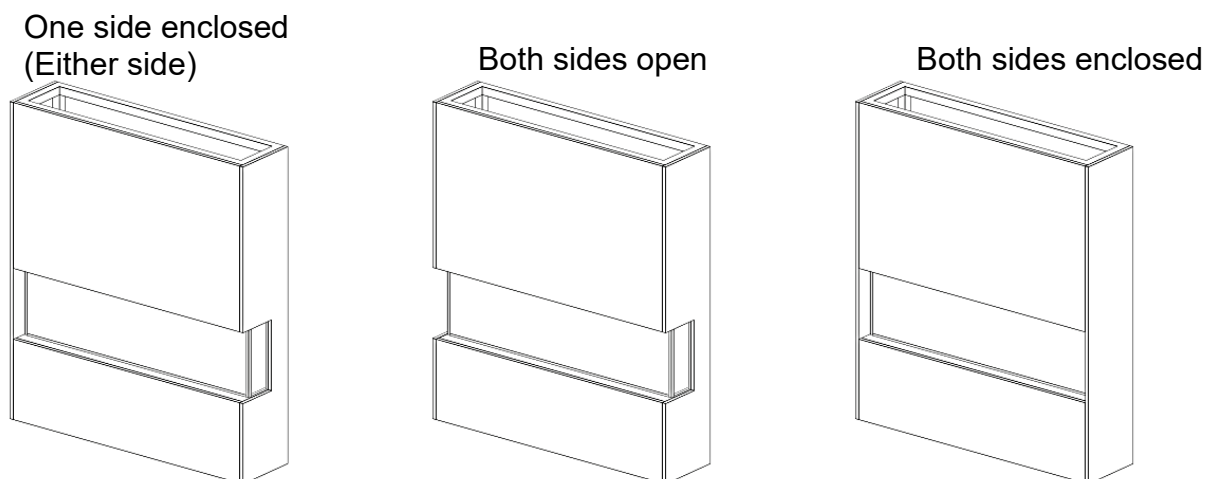

## INSTALLATION STYLE

Your fireplace can be installed either flush with the media wall, where the plasterboard meets the edge of the fireplace, or can be recessed so that the media wall covers the body of the fireplace, leaving only the main part of the fire visible.

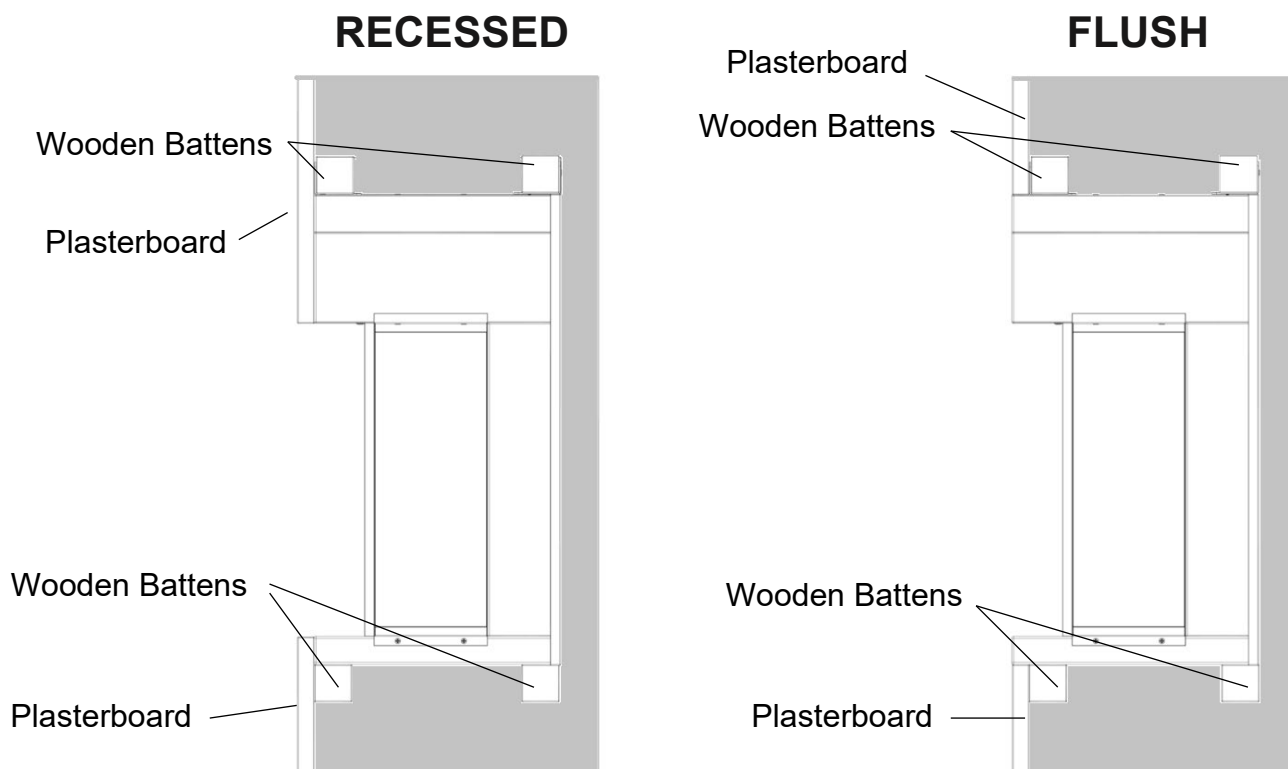

# MEDIA WALL REQUIREMENTS

Several factors must be considered when planning the construction of your media wall to ensure its success. We advise you to thoroughly read the installation instructions and understand the process before designing or constructing your media wall.

## 1) STRENGTH AND STABILITY OF THE STRUCTURE

The structure must be designed to be structurally sound and able to support the weight of the fire and any other items/shelving built into it. Consideration should be given to how the framework is secured to the walls. If you are unsure about the suitability of the planned structure, seek professional advice.

## 2) WHICH SIDES ARE VISIBLE FOLLOWING INSTALLATION

Your preference regarding the sides may impact the internal structure of the media wall, so this must be decided early in the project.

## 3) SUPPORT OF THE FIREPLACE

The fireplace requires wooden battens or other support methods to be mounted securely within the media wall.

**BASE OF THE FIRE** – The fire is designed to stand on a platform, or it can be supported using several wooden battens built into the structure of the media wall.

**TOP OF THE FIRE**- The fireplace uses two metal brackets, which are secured to the top of the fire through mounting points on the top of the fire. The brackets are designed to fix the fire to wooden battens located above the appliance. The brackets can be mounted at the front or rear of the fire, forward or backward facing, and secured into the batten from the front or behind. Although this offers a lot of flexibility for installation, care must still be taken to ensure that the battens' position aligns with the brackets' location.

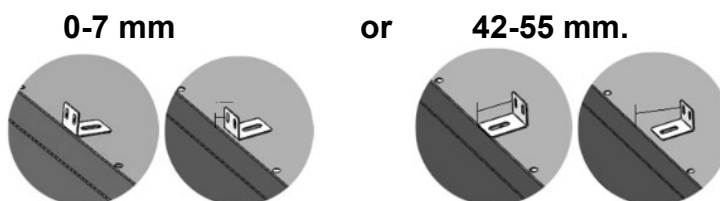

## 4) INSTALLATION STYLE

The installation style will also affect installation, as this will affect both the suitable position for the battens and the location of battens used for fixing the plasterboard.

## 5) ROUTE OF THE POWER CABLE

Consideration should be paid to the power cable route from the rear of the fire to the socket. It is strongly advised that the socket or fused spur to which the fireplace is attached is accessible following installation to allow the appliance to be disconnected if necessary.

**NOTE:** It is advisable to install the fire after the structure of the media wall has been erected but before the plasterboard has been applied, as access is required to secure the fire in place.



# PREPARING THE FIRE FOR INSTALLATION

Remove the screws holding the fixing bracket above the front glass panel, then carefully remove the bracket, and keep both the bracket and screws safe for reinstallation.

**Step 1**

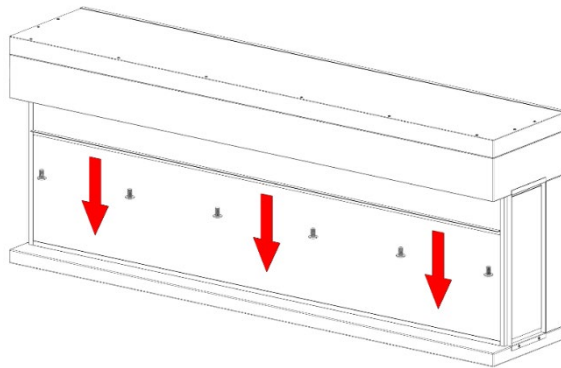

Remove the 8 screws holding the side panels in place and then carefully remove the side panels from each side and keep them safe for reinstallation.

**Step 2**

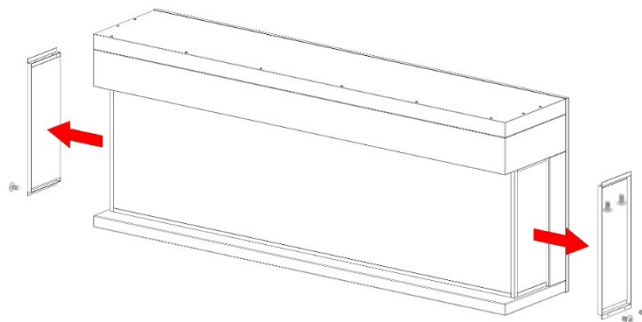

Remove the front glass panel using the glass suction cups. By tilting the glass, the power switch should be in the OFF position to allow the glass to pass before moving to the ON position to enable it to pass entirely. Place the glass on a soft, flat surface, ready for reinstallation.

**Step 3**

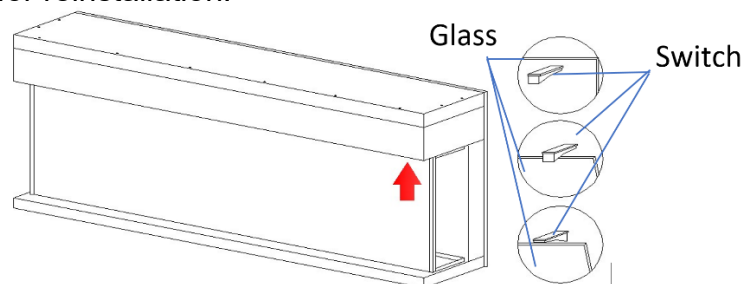

The decorative bed is two-sided, with a glittery and matt side.

**Matt:** Remove the protective film from the decorative bed.

**Glittery:** Remove the 3 screws from the decorative bed and flip the bed before re-securing.

**Step 4**

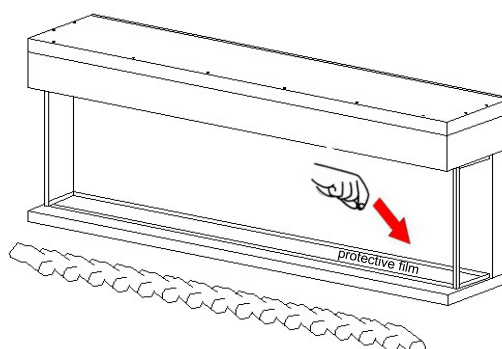

Replace the unit's glass panel, taking great care not to damage the glass. This would follow the same method as removal; when tilting the glass, ensure that the power switch is initially in the ON position to allow the glass to pass. You must remember to switch this back off before continuing.

**Step  
5**

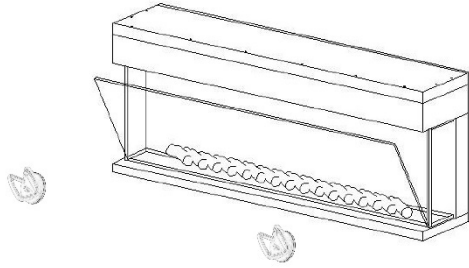

---

Replace the fixing bracket and secure it with the screws removed in step 1.

**Step  
6**

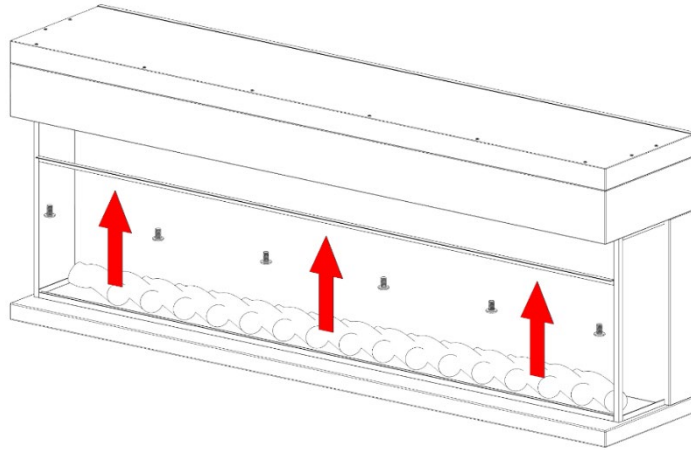

---

The side panels should then be refitted on either side, and they must be enclosed following installation. If you want the fireplace to be fully open, this step can be ignored.

**Step  
7**

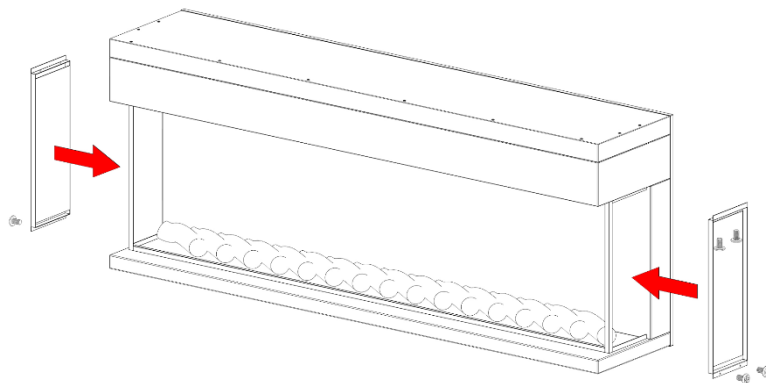

# INSTALLATION

Loosely fix the L-shaped brackets [A] into the chosen mounting points (Front or rear) on the top of the fire using SCREWS (B) and SHAKE PROOF WASHER (E).

**Step 1**

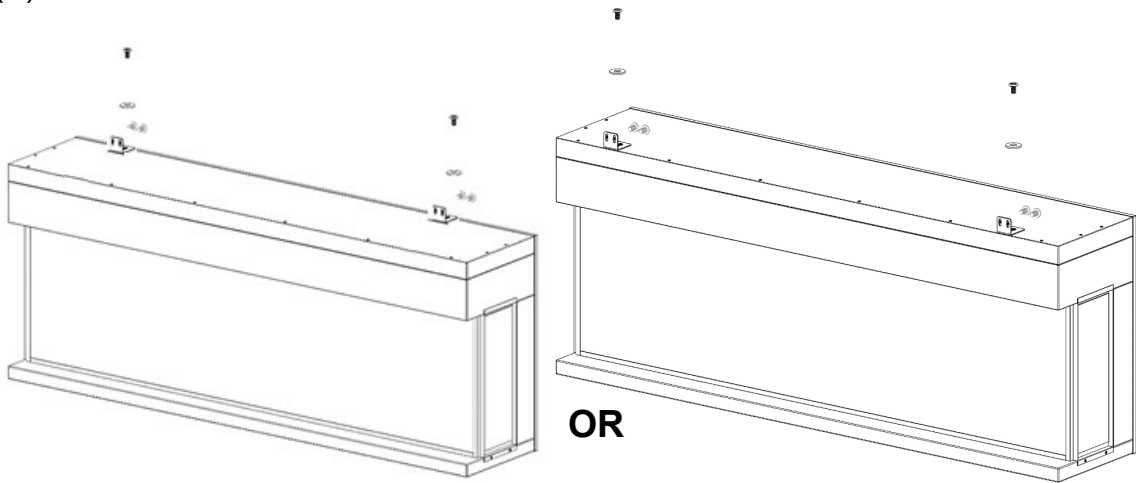

Slide the fire into position within the media wall. Adjust the brackets so that they sit flush with the wooden batten and so that the fire is in its intended position. Mark the bracket's position with a pencil.

**NOTE:** The brackets can be adjusted back and forth and turned 180° to suit the installation requirements. They can also be secured to the front or rear of the battens.

**Step 2**

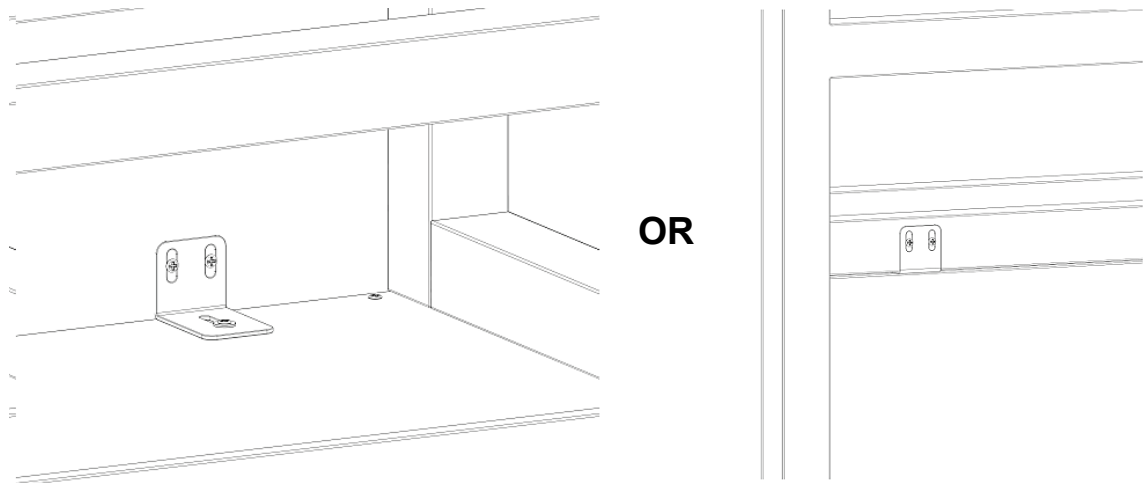

Remove the fire from the media wall, and fully tighten the brackets in the marked position on the top of the fire before sliding the fire back into position.

**Step  
3**

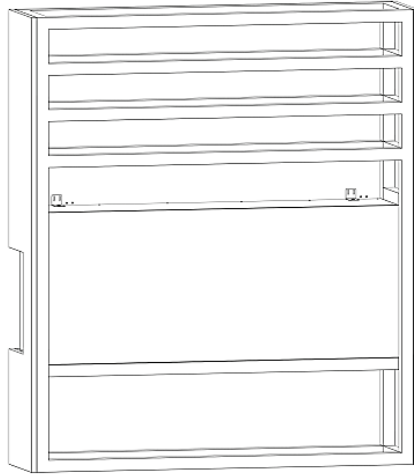

---

Secure the brackets to the media wall using SCREWS (C)

**Step  
4**

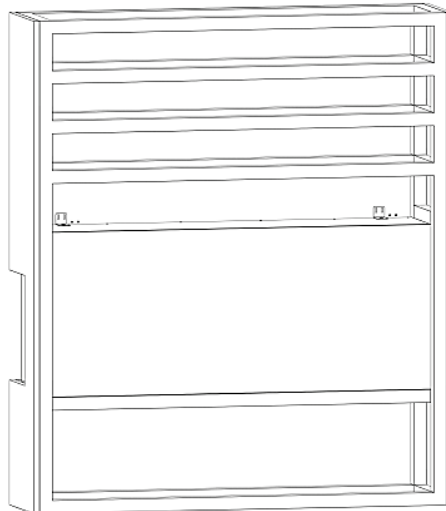

# OPERATION

The heater control panel is located on the right side of the heater.

**O/I:** Press the switch into the **I** position to turn the appliance on. Press the switch into the **O** position to turn the appliance off.

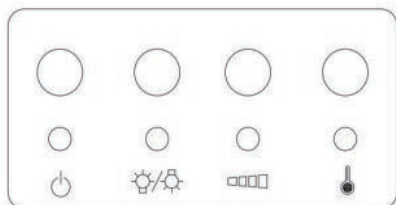

**CONTROL PANEL**

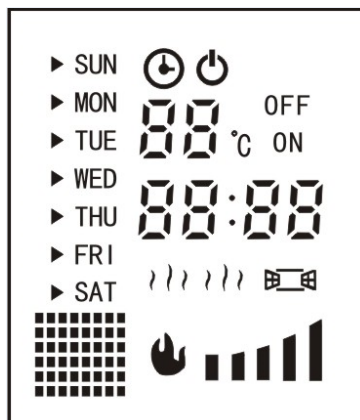

**DISPLAY**



**REMOTE CONTROL**

2 AAA batteries required (NOT INCLUDED)

## FUNCTIONS





















### CONTROL PANEL

FUNCTION	IMAGE	DESCRIPTION
<b>POWER</b>		When the unit is turned on using the switch, press the power button to start it. The indicator light will illuminate. You can then select the required function. Press again to turn off the heater and enter standby mode. Press and hold the power button for about 3 seconds to turn on the Wi-Fi function. Press and hold the power button again for about 3 seconds to turn it off.
<b>TEMPERATURE</b>		Repeatedly press to adjust the desired room temperature. Press and hold the temperature button for around 3 seconds to turn on the unit's heat function. Press and hold the temperature button again for approximately 3 seconds to turn the heat function off. The heat function can also be accessed using the remote control.
<b>FLAME EFFECT</b>		Press this button to change the flame effect. Press repeatedly to decrease the flame intensity. There are 5 light intensities, 5 being the brightest and 1 being the lowest. Press and hold this button for about 3 seconds to turn on the intelligent remote-control function. Please ensure that the Wi-Fi function is turned on before activating the function.
<b>COLOUR EFFECT</b>		Press this button to change the flame colour. There are ten types of flame effects. Hold it for about 3 seconds to change the top light colour. There are seven types of top light effects.

## REMOTE CONTROL

The remote control works best when used at the same level as the fire.

A slight delay may occur after a function is chosen using the remote. Please allow time before pressing the next button.

<b>POWER</b>		When the unit is turned on using the switch, press the power button to start the unit. Press again to turn off the heater and enter standby mode.
<b>TEMPERATURE</b>	<b>+ AND -</b>	Use to adjust the desired room temperature between 15°C and 40°C.
<b>SETTING THE DAY AND TIME</b>		<ol style="list-style-type: none"> <li>1) Press,  and 'SUN' will flash on the LED screen.</li> <li>2) Use the up ↑ and down ↓ buttons to select the correct day.</li> <li>3) Press  again to adjust the hour value.</li> <li>4) Use the + and – buttons to select the correct hour.</li> <li>5) Press  again to adjust the minute value.</li> <li>6) Use the + and – buttons to confirm the minute value.</li> <li>7) Press  or <b>OK</b> button to complete setting the day and time.</li> </ol>
<b>SET TIMER</b>		<p>The timer can be set with up to 10 periods of operation per week:</p> <ol style="list-style-type: none"> <li>1) Press  and the time period will flash.</li> <li>2) Use the + and – buttons to choose the desired time period to adjust (1 to 10).</li> <li>3) Press  and the day will flash.</li> <li>4) Use the ↑ and ↓ buttons to choose which days the timer will operate. Use the + to select the flashing day, and – to cancel the flashing day.</li> <li>5) Press  and the hour will flash and ON will be illuminated.</li> <li>6) Use the + and – buttons to choose the desired start hour.</li> <li>7) Press  and the minute value will flash.</li> <li>8) Use the + and – buttons to choose the desired start minute.</li> <li>9) Press  and the hour value will flash and OFF will illuminate.</li> <li>10) Use the + and – buttons to choose the desired finish hour.</li> <li>11) Press  and the minute value will flash.</li> <li>12) Use the + and – buttons to choose the desired finish minute.</li> <li>13) Press  and the temperature will flash.</li> <li>14) Use the + or – buttons to select the desired temperature.</li> </ol> <p>Repeat for each of the 10 time periods you want to set.</p>
<b>OPEN WINDOW DETECTION</b>		Press this button to turn on the open window detection function. When activated, if the room temperature drops rapidly while heating, it will automatically stop heating to save energy. The corresponding icon on the screen will flash. Press the button again to turn off the window detection function.
<b>RESET</b>		Press to clear any timer that has been set.
<b>TIMER</b>		Press to turn the timer on or off. When activated, the timer will follow the settings programmed using the set timer button. The timer indicator will illuminate to show that the timer has been set.
<b>FLAME EFFECT</b>		<p>Press this button to change the flame colour. There are ten types of flame effects: Yellow, blue, red and multi-colour. Hold the button for about 3 seconds to decrease the flame intensity.</p> <p>There are 5 light intensities, with 5 being the brightest intensity and 1 being the lowest intensity.</p>
<b>TOP LIGHT EFFECT</b>		Press this button to change the top light effect. There are seven types of top light effects: Blue, Green, Red and multi-colour.
<b>HEAT FUNCTION</b>		Press this button to turn on the heat function. Press again to turn it off.

## SETTING UP THE WIFI APP

This is designed as a general guide to the setup. There may be differences in the interface and features available due to product development and features of the model.

### BEFORE YOU START

- Ensure your router provides a standard 2.4 GHz connection.
- If your router is dual-band, ensure that both networks have different network names (SSID). Your router's provider or Internet service provider can provide advice specific to your router.
- Place the device as close as possible to the router during setup.
- Once the app has been installed on your phone, turn off the data connection and ensure your phone is connected to your router via Wi-Fi.

### DOWNLOAD THE APP TO YOUR PHONE

You can download the "TUYA SMART" app from your chosen app store by using the QR codes below or searching for the app in your chosen store.

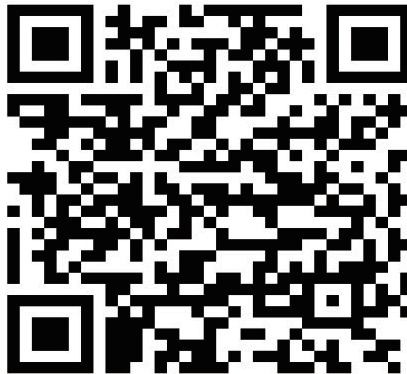

Android



IOS

# APP CONNECTION

**NOTE:** Due to continuous product improvement, some images may differ from the current app. You can download it from the Apple or Google Play Store.

1. Press the register button at the bottom of the screen.
2. Read the Privacy policy and press the Agree Button.
3. Enter your email address or phone number and press continue to register.

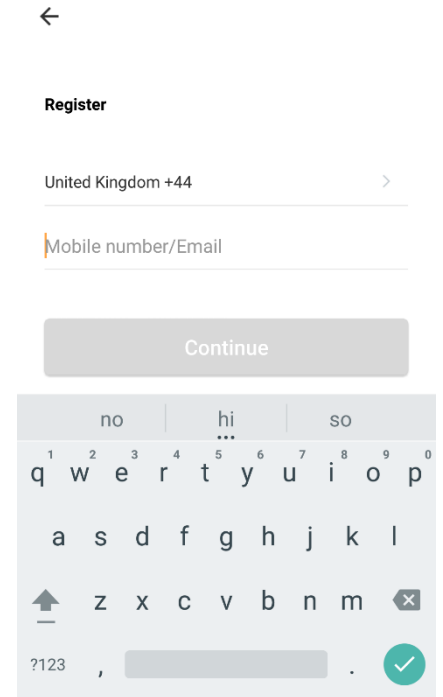
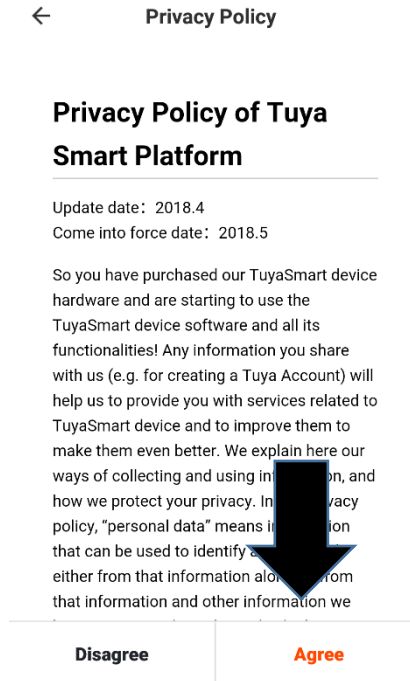
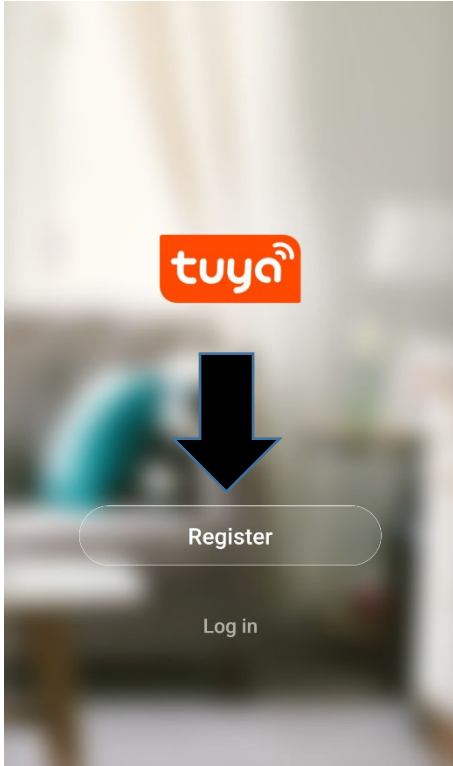

4. A verification code will be sent using the method selected in step 3. Enter the code into the app.
5. Type in the password you would like to create. This needs to be 6-20 characters, with letters and numbers.
6. The app is now registered. It will automatically log you in following registration.

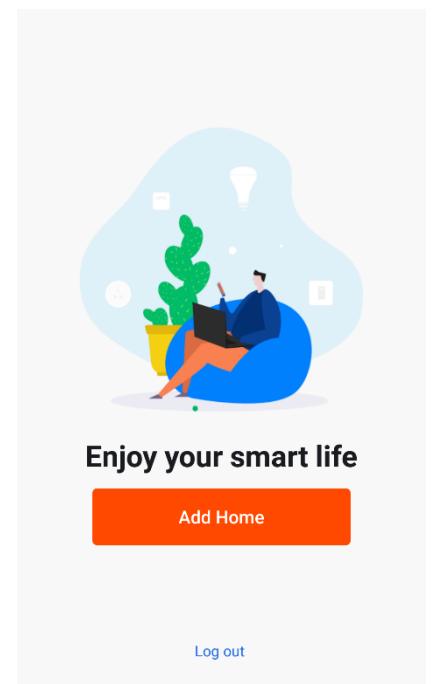
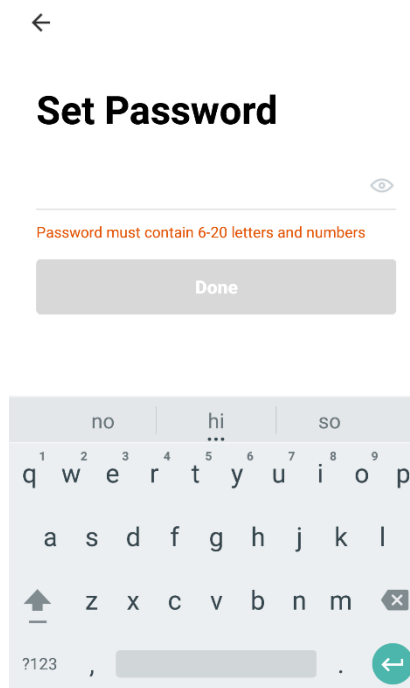
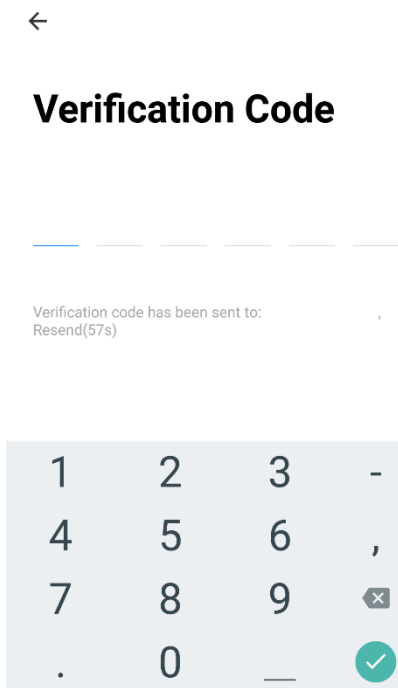



# SETTING UP YOUR HOME WITHIN THE APP

The app allows you to have multiple homes, rooms, and devices, so you will need to set up at least one to get started.

1. Select 'Me' at the bottom of the screen, then 'Home Management'.

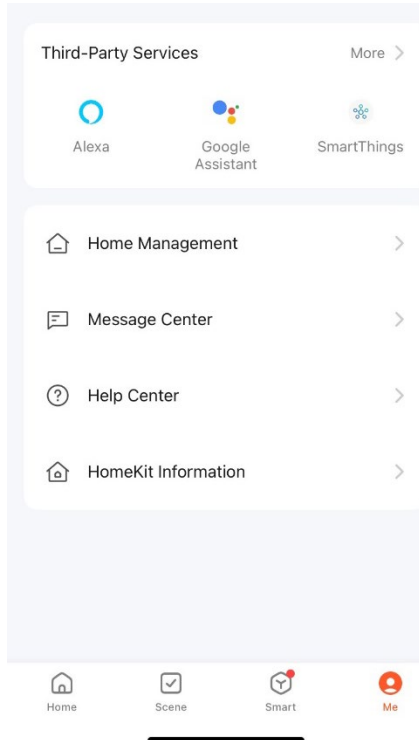

2. Create and name your home, join a home or use the home you have set up already.

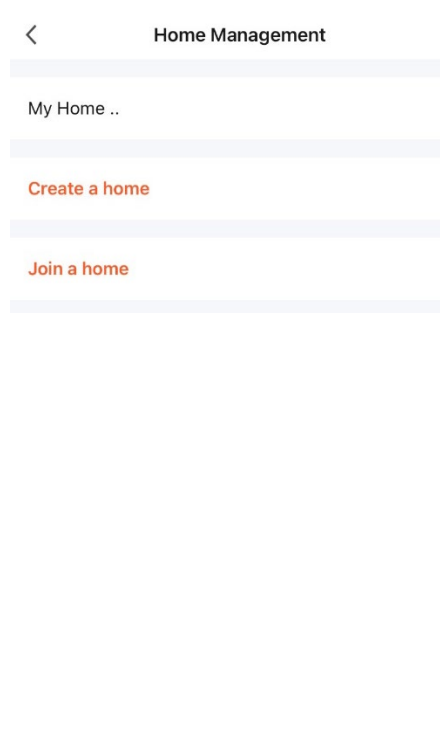

3. Select a location to either allow the app to pinpoint your location via GPS in your phone settings or type/ drop the pin on the map.

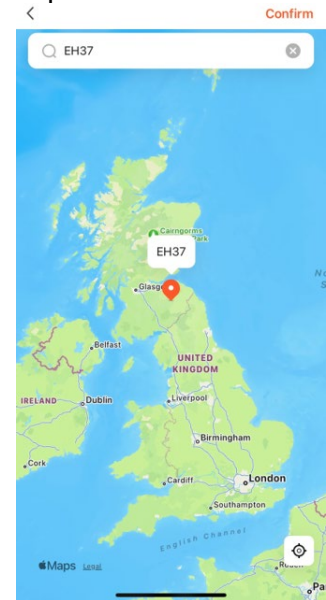

4. Select your rooms. Untick any rooms that you do not need. Click and add a room if you require more.

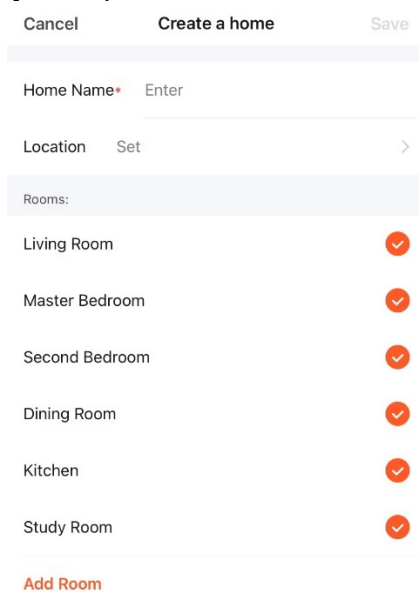

5. Add another room and type in the name or select an option. Then select confirm.

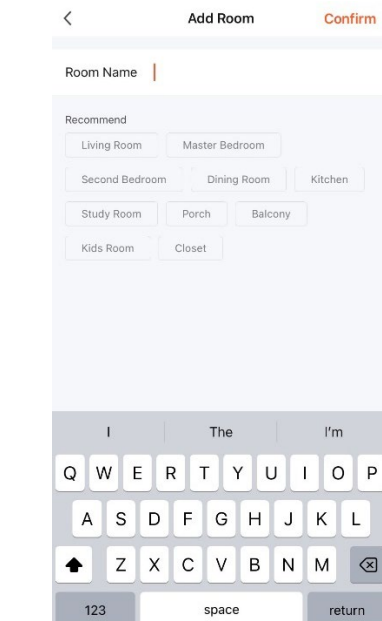

6. Select the room your unit is in. Then click on the green cross to add the device to that room, then save.

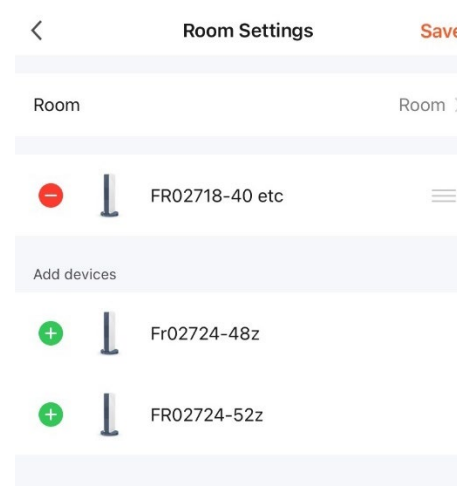

## CONNECTING TO THE UNIT

1. Turn the fire on using the power button. Hold down the Power button for 3 seconds to turn the Wi-Fi on.



2. Hold down the flame effect button for 3 seconds to turn the intelligent control on.



3. On the app, now select the 'Add' button in the top corner. Then 'Add Device'.

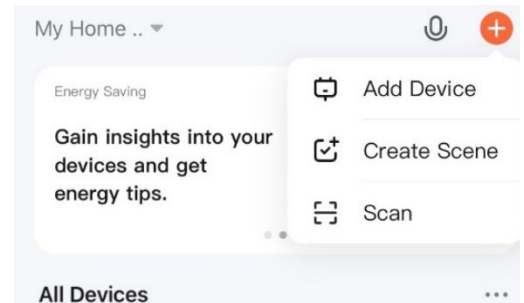

4. Ensure your phone is connected to the same Wi-Fi as the unit. Then select 'Small Home Appliances', then electric fires.

5. Confirm the indicator is blinking on the app (if it is, return to step 1 if not).

6. Enter the Wi-Fi password and then wait for the transfer of the settings to be completed.

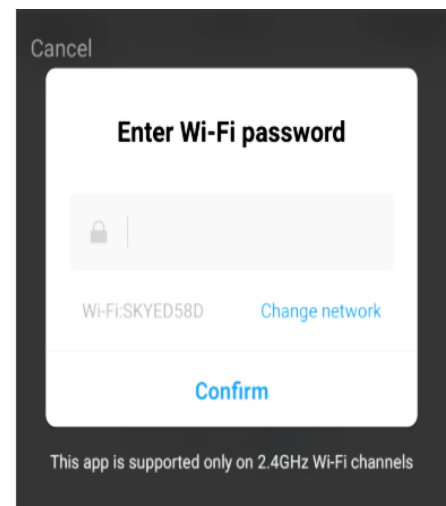
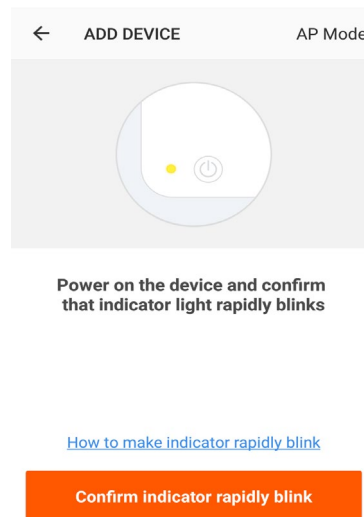

# CONTROLLING THE DEVICE VIA THE APP

## HOME SCREEN

**Voice Control:** Press to give verbal instructions for operation.

**Add Device:** Add a device to the app and go through the setup process.

**Name of Heater:** Press to enter the Device Screen

**Home:** Return to home screen from the Smart Scene and Profile screens

**Profile:** Provides the option for changing settings.

**Scene:** Allows you to program intelligent behaviour based on the internal and external environment.

**Smart:** Shows you smart insights and allows you to set up alerts, cameras and alarms.

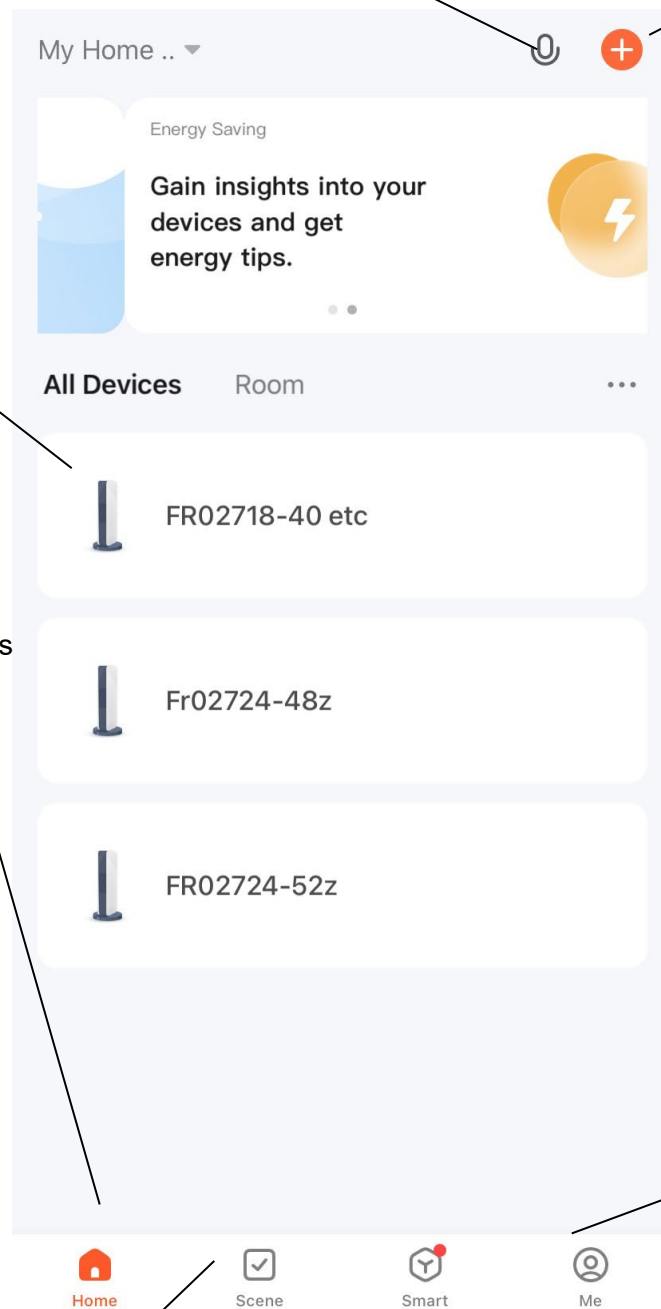

## DEVICE SCREEN

**Back:** Returns to the Home Screen

**Device Name**

**Desired Temperature:**  
Displays what has been set as the target room temperature.

**Current Temperature:**  
Displays what the current temperature is.

**Decrease Desired Temperature**

Temperature range  
15-40°C

**Increase Desired Temperature**

Temperature range  
15-40°C

**Power:** Use to turn the unit on or off.

**Settings:** Enter the settings menu. You can access temperature scale, flame brightness, downlights colour and the timer schedule.

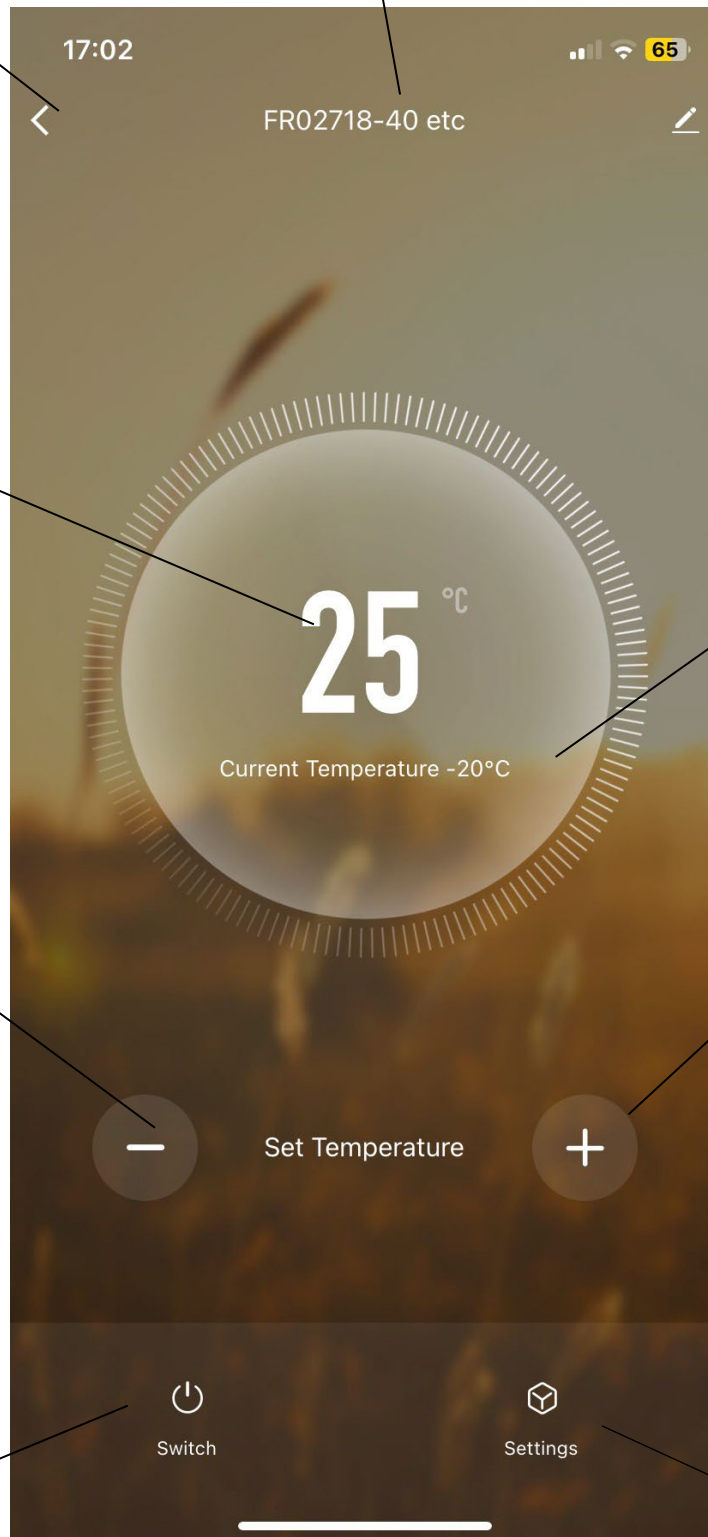

## DEVICE SETTINGS

**HEAT:** To turn the heat on or off.

**FLAME COLOUR:** Click to change the flame colour.

**BACKLIGHT COLOUR:** Click to change the backlight colour,

**FLAME BRIGHTNESS:** Change the flame brightness or turn the flames on or off.

**OPEN WINDOWS:** Turn on open window detection.

**TIMER:** Schedule a timer to turn the device on or off.

### ADDING A TIMER:

Click add.

Select the time you want the device to turn on or off.

Select 'Repeat' if you would like this to be scheduled for certain days.

You can add a note to name the schedule.

Click 'Switch' to choose if the schedule is to turn on or off the device.

Then click save.

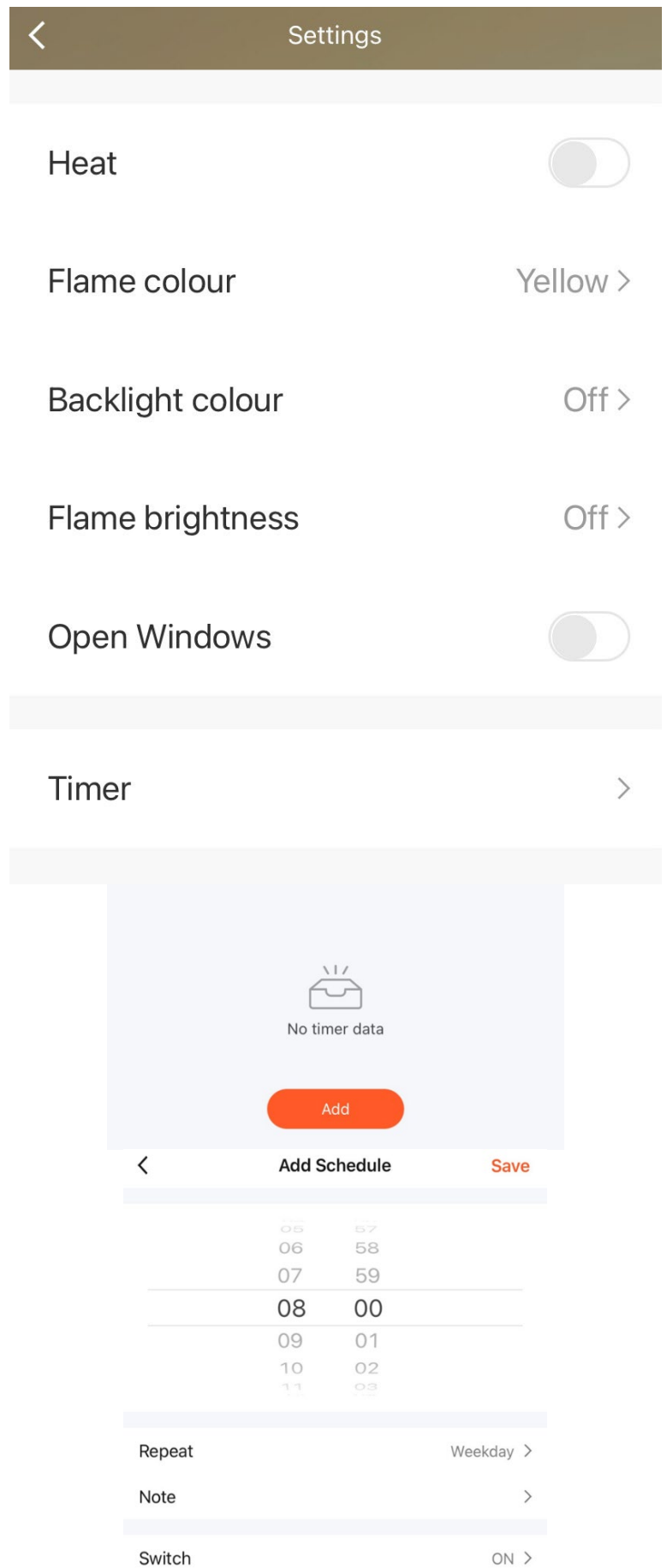

## PROFILE TAB

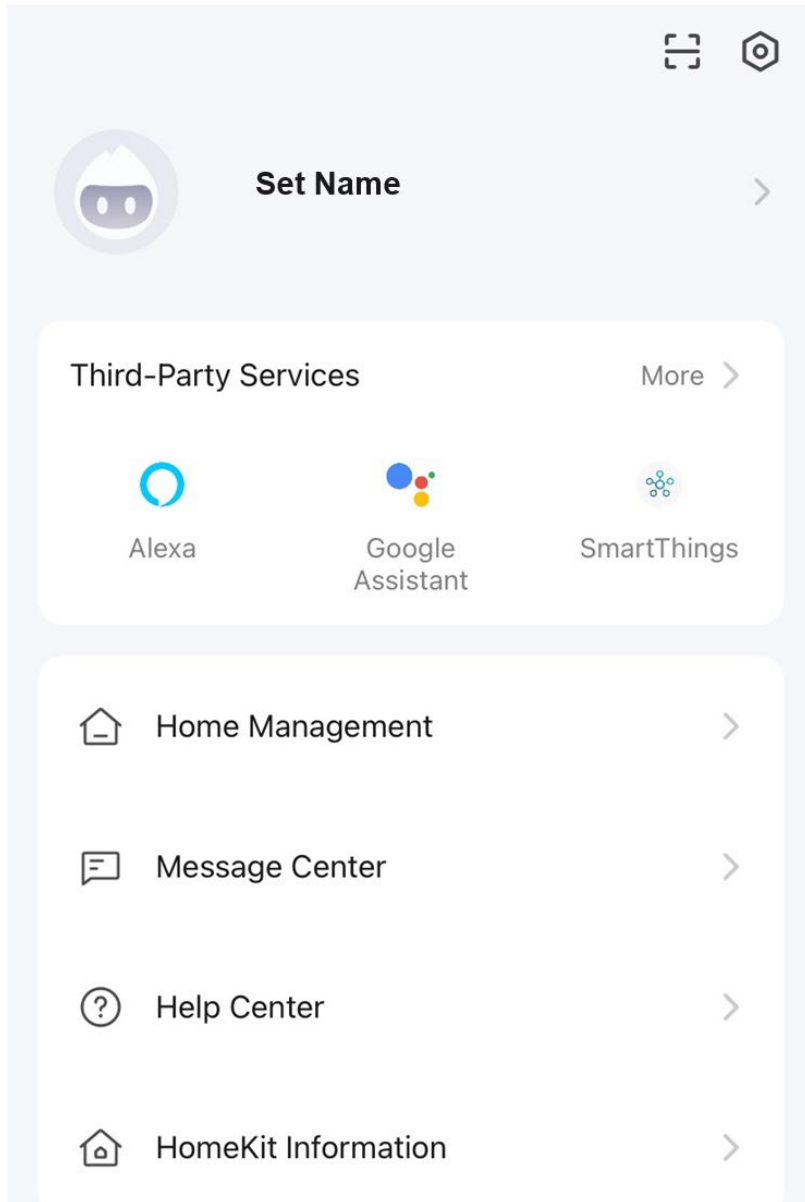

The profile tab allows you to edit both your details and use the added features of the unit.

### HOME MANAGEMENT

Home Management provides options for managing your TUYA account, such as adding a home, adding and removing rooms, and sharing devices with family.

### MESSAGE CENTRE

View notifications from devices if alarms are set up (dependent on the device).

### HELP CENTRE

Aids using the features provided within the app.

### HOME KIT INFORMATION

Allows you to add home switches that are compatible with the TUYA app.

## CONNECTION TROUBLESHOOTING

1. Check whether the device is powered on and in WiFi connection mode.
2. Ensure the WiFi password has been entered into the app correctly (Case sensitive)
3. Check that the phone is connected to the WiFi you are connecting the device to.
4. Ensure the network you are connecting to is 2.4 GHz (5 GHz WiFi networks are not supported) and that the item has a strong WiFi signal.
5. If your router is dual band, ensure that the 2.4 GHz network has a different network name (SSID). Your Internet service provider or router manufacturer can provide further advice on changing router settings.
6. Check the settings on the router. Encryption should be WPA2-PSK, and the authorisation type should be set to AES.

## CARE AND MAINTENANCE

When cleaning the appliance, the power should be disconnected, and the unit should be cool.

Dust can be removed by lightly wiping the glass surface with a clean, lint-free cloth or paper towel. Fingerprints or other marks can be removed using a damp cloth and a good-quality household glass cleaner. The front glass panel should be thoroughly dried before reusing the heater.

### CAUTION:

- Do not use an abrasive cleaner on the glass panels.
- Do not spray liquids directly onto any surface of the unit.
- Do not clean the glass on the inside of the unit, as this may cause damage to the surface.
- The decorative logs may leave a residue on the fuel bed; this is normal and can be cleaned with a soft, damp cloth. Ensure the fire is cool and turned off before cleaning the fuel bed. Ensure any water residue from cleaning has been dried before using the fire.

## TROUBLESHOOTING

Most problems are simple to resolve - please refer to the following table before calling a service engineer:

Problem	Possible Cause	Check
The fire has stopped working.	The fire has overheated, the thermal safety device has been activated, or a circuit breaker has tripped.	<ul style="list-style-type: none"><li>• Check there is power to the socket where the fire is connected.</li><li>• Check the fuse in the plug,</li><li>• Leave for 10 minutes in case of thermal cut-out.</li></ul>
The flame is not moving.	Flame motor defective	Contact the retailer or manufacturer.

## SERVICING

A competent person must conduct any servicing or repairs after reading the service manual. Customer service can provide the service manual by emailing [CSTechSupport@buyitdirect.co.uk](mailto:CSTechSupport@buyitdirect.co.uk).

# WASTE ELECTRICAL RECYCLING

This symbol indicates that this product is classified as electrical or electronic equipment and should not be disposed of with other household waste.

The Waste Electrical and Electrical Equipment (WEEE) Directive has been introduced across the European Union:

- To recycle waste electrical products using the best available recovery and recycling techniques in order to minimise the impact on the environment.
- To treat any hazardous substances.
- To avoid increasing landfills.



WEEE product should be disposed of by handing it over at a designated collection point. Please contact your local authority for more information about where you can drop off your waste product for recycling.

## SUPPORT

Please, for your own convenience, make these simple checks before calling the service line. If the unit still fails to operate, call 0330 390 3062 or log in to your online account to complete an online return.

1. Is the unit plugged into the mains?
2. Is the fuse OK?
3. Switch the unit off and wait ten minutes to see if the issue is resolved. Restart the unit.

**[www.furniture123.co.uk/content/customer-services](http://www.furniture123.co.uk/content/customer-services)**

**0330 390 3062**

**Office hours: 9 AM - 5 PM, Monday to Friday**

BuyItDirect  
Unit 2A, Trident Business Park,  
Neptune Way, Leeds Road,  
Huddersfield, HD2 1UA.



## TECHNICAL SPECIFICATION

	Fully inset media wall fire.			
Model	AGL073	AGL067W	AGL068W	AGL069W
Rated Voltage	220-240V~	220-240V~	220-240V~	220-240V~
Rated Frequency	50-60Hz	50-60Hz	50-60Hz	50-60Hz
Rated Power	Max 1800W	Max 1800W	Max 1800W	Max 1800W
Dimensions (H) x (L) x (D)	50x101.6x26.2cm	50x127x26.2cm	50x152.4x26.2cm	50x177.8x26.2cm
Weight	28.7kg	35.87Kg	42.73Kg	50.08Kg



Model identifier(s): <b>AGL073 AGL067W AGL068W AGL069W</b>					
Item	Symbol	Value	unit	Item	unit
<b>Heat output</b>				<b>Type of heat input, for electric storage local space heaters only (select one)</b>	
Nominal heat output	$P_{nom}$	1.8	kW	manual heat charge control, with integrated thermostat	No
Minimum heat output (indicative)	$P_{min}$	0	kW	Manual heat charge control with room and/or outdoor temperature feedback	No
Maximum continuous heat output	$P_{max,c}$	1.8	kW	Electronic heat charge control with room and/or outdoor temperature feedback	No
Auxiliary electricity consumption				Fan assisted heat output.	
At nominal heat output	$e_{lmax}$	N/A	kW	<b>Type of heat output/room temperature control (select one)</b>	
At minimum heat output	$e_{lmin}$	N/A	kW	single stage heat output and no room temperature control	No
In standby mode	$e_{lsb}$	0.3	W	Two or more manual stages, no room temperature control	No
				with mechanic thermostat room temperature control	No
				with electronic room temperature control	No
				electronic room temperature control plus day timer	No
				electronic room temperature control plus week timer	Yes
				<b>Other control options (multiple selections possible)</b>	
				room temperature control, with presence detection	No
				room temperature control, with open window detection	Yes
				with distance control option	No
				with adaptive start control	No
				with working time limitation	Yes
				with a black bulb sensor	No
Unit 2A, Trident Business Park, Neptune Way, Leeds Road, Huddersfield, HD2 1UA The Black Church, St. Mary's Place, Dublin 7					

## PSTI STATEMENT OF COMPLIANCE

Description: **MEDIA WALL ELECTRIC FIREPLACE**

Model Number: **AGL073, AGL067W, AGL068W, AGL069W.**

Manufacturer: electriQ, 2A Trident Business Park, Leeds Road, Huddersfield, HD2 1UA

PSTI Contact: [TiSecurity@buyitdirect.co.uk](mailto:TiSecurity@buyitdirect.co.uk)

We have prepared this statement of compliance and can confirm that this product is compliant with the deemed compliance conditions in Schedule 2 of The Product Security and Telecommunications Infrastructure (Security Requirements for Relevant Connectable Products) Regulations 2023.

Duration of security updates: 30/12/2029. This date is correct at the time of printing, but we may be extended. Please visit [www.electriQ.co.uk](http://www.electriQ.co.uk) for the latest information and details of our PSTI compliance.



Richard Leach

Compliance and Quality Manager, Buy It Direct, Huddersfield

10<sup>th</sup> April 2024

## EU DECLARATION OF CONFORMITY

Hereby, Better Bathrooms declares that these towel rails are in compliance with Directive 2104/53/EU.

The full text of the EU Declaration of Conformity is available at the following internet addresses:

<https://furniture123.co.uk/files/DOC/EU/AGL067W.pdf>

<https://furniture123.co.uk/files/DOC/EU/AGL068W.pdf>

<https://furniture123.co.uk/files/DOC/EU/AGL069W.pdf>

<https://furniture123.co.uk/files/DOC/EU/AGL073.pdf>

## UK DECLARATION OF CONFORMITY

Hereby, Better Bathrooms declares that these towel rails are in compliance with the Radio Equipment Regulations 2017

The full text of the EU Declaration of Conformity is available at the following internet addresses:

<https://furniture123.co.uk/files/DOC/UK/AGL067W.pdf>

<https://furniture123.co.uk/files/DOC/UK/AGL068W.pdf>

<https://furniture123.co.uk/files/DOC/UK/AGL069W.pdf>

<https://furniture123.co.uk/files/DOC/UK/AGL073.pdf>

V20241111SS